

YAMAHA NETWORK BOARD **SRC**D/SRCP
ERCX/SR**C**X/D**R**CX

PROFIBUS

User's Manual

ENGLISH 

YAMAHA MOTOR CO., LTD.

IM Operations

882 Soude, Naka-ku, Hamamatsu, Shizuoka 435-0054.Japan
URL <http://www.yamaha-motor.jp/robot/index.html>

E88-Ver. 2.01

INTRODUCTION

Thank you for purchasing the PROFIBUS unit for the YAMAHA single-axis/dual-axis robot controllers SRCP/SRCD/ERCX/SRCX/DRCX series.

This is an optional unit to allow connecting YAMAHA single-axis/dual-axis robot controllers SRCP/SRCD/ERCX/SRCX/DRCX series (hereafter called "controller") to the PROFIBUS widely used as a fieldbus.

This manual describes typical examples for taking safety measures, installing wiring, making machine settings and operating the machine to ensure that the PROFIBUS unit is used safely and effectively. After reading this manual keep it in a safe, easily accessible location, so it can be referred to whenever needed. When moving this unit, always make sure this manual accompanies it, and make sure that the person who will actually use this PROFIBUS unit reads this manual thoroughly.

This manual only contains information involving the PROFIBUS unit. Please refer to the controller user's manual for information about basic controller operation and programming, etc.

The HPB screen displays in this manual are for the DRCX series controllers (hereafter called "dual-axis controller") and so may differ somewhat from the HPB screen display for the SRCP/SRCD/ERCX/SRCX series controllers (hereafter called "single-axis controller"). Please note that this will cause no problem with the functions of the controller or PROFIBUS unit.

CAUTION

- **The contents of this manual may be changed in advance without prior notice.**
 - **Every effort was made to ensure the contents of this manual are complete, however please contact us if errors, ambiguities or possible trouble points are found.**
 - **This manual does not constitute a warranty of industrial rights or other rights nor a concession of utility rights. Further, no responsibility whatsoever is accepted for problems arising from use of the information contents listed in this manual.**
-

MEMO

Contents

Cautions To Ensure Safety	1
1-1 Basic safety points	2
1-2 System design safety points	2
1-3 Installation and wiring safety points	3
1-4 Start-up and maintenance safety points	4
1-5 Precautions when disposing of the unit	4
1-6 Warranty	4
PROFIBUS Unit	5
2-1 PROFIBUS unit features	6
2-2 PROFIBUS system concept	7
2-3 PROFIBUS cable connections	8
2-4 Parallel I/O connector	9
2-5 Controller (slave station) system setting	11
2-5-1 Validating the PROFIBUS unit	11
2-5-2 Setting the station address	12
2-5-3 Checking the communication speed	13
2-6 Sequencer (master station) settings	14
2-6-1 Exchanging data with the controller	14
2-7 I/O information	15
2-7-1 Profile (I/O signal table)	15
2-7-2 Dedicated command inputs	17
2-7-3 General-purpose inputs (SI200 - SI231)	21
2-7-4 Interlock (LOCK)	22
2-7-5 Emergency stop input (EMG)	22
2-7-6 Service mode (SVCE)	23
2-7-7 Dedicated outputs	24
2-7-8 General-purpose outputs (SO200 - SO231)	25
2-8 Timing chart	26
2-8-1 Right after controller power turns on	26
2-8-2 Dedicated input command execution	27
2-8-3 When interlock signal is input	31
2-8-4 When emergency stop signal is input	32
2-8-5 When an alarm is issued	33
2-8-6 When point movement commands are run	34
2-9 I/O assignment change function	35
2-9-1 Changing the I/O assignment	35
2-9-2 I/O assignment list	36
2-9-3 I/O assignment selection parameter description	38
2-9-4 I/O signal description	40
2-9-5 Timing chart	45
2-10 Robot language	55
2-10-1 MOVF	55

2-10-2	JMPF	56
2-10-3	JMPB	57
2-10-4	DO	57
2-10-5	WAIT	58
2-11	Emulated Serialization on parallel DIO	59
2-12	Remote command	61
2-12-1	Remote command specifications	61
2-12-2	Remote command & status value list	62
2-12-3	Remote command details (robot operation)	66
2-12-4	Remote command details (data handling)	100
2-12-5	Remote command details (utilities)	123
2-12-6	Remote command details (Special commands)	127
2-12-7	Status details	128
2-12-8	Current position indication mode	129
2-12-9	Sending/receiving example	130
2-13	Other operations	131
2-13-1	Serial I/O display	131
2-13-2	Manual control of general-purpose output	134
2-14	Error Message	135
2-15	Troubleshooting	136
2-16	Specifications	138
2-17	Supplement	139
2-17-1	GSD files	139

CHAPTER

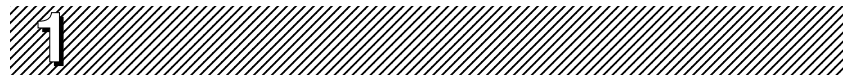

Cautions To Ensure Safety

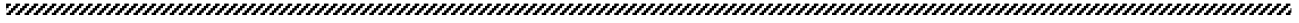

1-1 Basic safety points

Besides reading this instruction manual and the controller user's manual, also be sure to handle the equipment correctly while paying sufficient attention to safety.

Points regarding safety in this instruction manual only list items involving this product. Please refer to the controller instruction manual for information regarding safety when using this unit with the controller.

It is not possible to detail all safety items within the limited space of this manual. So it is essential that the user have a full knowledge of basic safety rules and also that the operator makes correct judgments on safety procedures during operation.

Industrial robots are highly programmable, mechanical devices that provide a large degree of freedom when performing various manipulative tasks. Failure to take necessary safety measures or mishandling due to not following the instruction in this manual may result in trouble or damage to the robot and injury to personnel (robot operator or service personnel) including fatal accidents.

Important caution points in this manual are from hereon indicated by the term:



1-2 System design safety points



When communication errors occur in the PROFIBUS system, check the status of the network system and the controller beforehand by referring to the PROFIBUS instruction manual and this instruction manual. Also use this communication status information to contrive circuits and interlocks in the sequence program so that the system including the controller will operate safely.



Emergency stop signals may sometimes interrupt register operation in the PROFIBUS unit, however this is merely a software control process and is in no way a problem. Therefore, we strongly advise contriving a hardware interlock circuit connected to the emergency stop pin contacts in the parallel I/O of the controller.



Do not bundle control lines or communication cables together or in close contact with main circuit or motor/actuator lines. As a general rule, maintain a gap of at least 100mm. Noise in signal lines may cause faulty operation.

1-3 Installation and wiring safety points

⚠ CAUTION

Always cut off all power to the controller and the overall system before attempting installation or wiring jobs. This will prevent possible electrical shocks.

After the controller has been on for a while, some points in the controller may be extremely hot or remain at high voltages. After cutting off the power when installing or removing the unit, wait at least 5 minutes before starting work.

⚠ CAUTION

Always uses the system specifications as listed in the controller instruction manual during installation or wiring work on the controller. Attempting to use other than these system specifications might cause electrical shocks, fire, faulty operation, product damage or deteriorated performance.

⚠ CAUTION

Securely install the connectors into the unit, and when wiring the connectors, make the crimp, contact or solder connections correctly, using the tool specified by the manufacturer. Poor connections will cause faulty operation.

⚠ CAUTION

When installing the unit, be careful not to directly touch any electronic components (except DIP switches) or parts conducting electrical current.

⚠ CAUTION

Make sure that foreign matter such as wiring debris or dust does not penetrate into the controller.

⚠ CAUTION

Always store network cable inside cable ducts or clamp them securely in place. Otherwise, excessive play or movement, or mistakenly pulling on the cable may damage the unit or cables, or poor cable contact may lead to faulty operation.

⚠ CAUTION

When detaching the cable, remove by holding the connector itself and not by tugging on the cable. Otherwise, removing by pulling on the cable itself may damage the unit or cables, or poor cable contact may lead to faulty operation.

1-4 Start-up and maintenance safety points

⚠ CAUTION

Never attempt to disassemble the robot or controller. When a robot or controller component must be repaired or replaced, contact us for details on how to perform the servicing.

⚠ CAUTION

Always cut off all power to the controller and the overall system before attempting maintenance or servicing. This will prevent possible electrical shocks. After the controller has been on for a while, some points in the controller may be extremely hot or remain at high voltages. After cutting off the power when installing or removing the unit, wait at least 5 minutes before starting work.

⚠ CAUTION

Do not touch the terminals (or pins) while power is still applied to the unit. This may cause electrical shocks or faulty operation.

1-5 Precautions when disposing of the unit

⚠ CAUTION

This product must be properly handled as industrial waste when its disposal is required.

1-6 Warranty

For information on the product warranty, please contact your local agent where you purchased your product.

CHAPTER

2

PROFIBUS Unit



2-1 PROFIBUS unit features

PROFIBUS is a fieldbus standard jointly developed by Siemens, Bosch, ABB, etc. in Germany in the 1980s. The PROFIBUS specifications were established in 1989 and the organization called "PNO" (PROFIBUS Nutzerorganisation) was founded in Germany to start activities to spread the PROFIBUS.

To allow PROFIBUS to be used more effectively according to the specification purpose, the PROFIBUS family is composed of two types of buses: PROFIBUS DP for factory automation and PROFIBUS PA for process automation.

Main features of this PROFIBUS unit are as follows:

- The controller can be connected to the PROFIBUS system using this unit. This unit fits directly inside the controller and so does not require any extra installation space.
- The PLC is connected to the robot system using only one dedicated cable (with 5 wires). This allows the entire system wiring to be reduced and also makes wiring tasks faster and more efficient while reducing maintenance and installation costs.
- A total of 32 general-purpose input/output pins and 16 dedicated input/output pins are available. The parallel I/O interface can of course be used as is.
- Emulated serialization on parallel I/O is available
All types of I/O equipment, such as sensors and relays, connected to the parallel I/O of the controller can be controlled from the PLC (sequencer) just as if connected to the I/O of the PROFIBUS system and without using a robot program.
- When the remote register is used, the message (remote command) can be issued directly from the sequencer (PLC). The high-ranked commands such as MOVD command (movement command which directly specifies the position coordinates), which must use RS-232C unit conventionally, can be easily executed.

Refer to the particular service manual involved when detailed information on connecting to the master station PLC (sequencer) or on PLC (sequencer) programs is needed when using other equipment.

Refer to the controller instruction manual for information involving operating the controller unit and on robot programming.

2-2 PROFIBUS system concept

In order to understand how the controller and sequencer (PLC) operate on the PROFIBUS system, let's first take a look at how the system communicates.

Each unit connected in the PROFIBUS system is classified by function into a master station and a slave station. The master station determines data communication and is equivalent to a master PLC (sequencer) unit. The slave station is controlled by the master station and processes data in response to a request from the master station.

The controllers equipped with the PROFIBUS unit operate as slave stations and exchange I/O information with the master station.

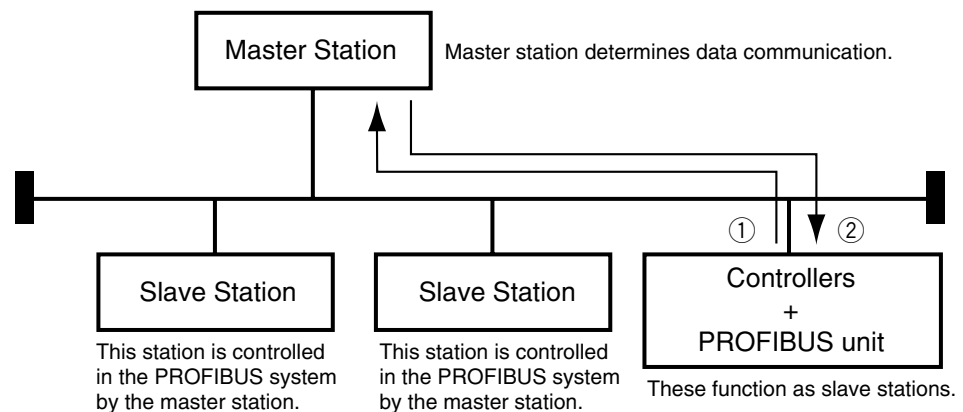

- ① The controller on/off information is sent to the master station via the information network (PROFIBUS system cable). Moreover, the response from the controller against the message (remote command) is also similarly sent to the master station via the network.
- ② Master station sequencer (PLC) on/off information is sent to the controller via the information network (PROFIBUS system cable). Moreover, the message (remote command) from the master station is also similarly sent to the master station via the network.

* The controller monitors the on/off information and message (remote command) at 10 millisecond intervals.

MEMO

Station address is set from the HPB. Communication speed is automatically selected. ON/OFF information handled by the PROFIBUS unit comes through 32 general-purpose I/O pins and 16 Dedicated I/O pins.

ON/OFF information in the robot program is handled by DO statements, WAIT statements, and JMPB statements. (Serial input/outputs (I/O) for the PROFIBUS are assigned using I/O numbers from 200 onwards.) Designated I/O ports can be controlled independently of the program by making emulated serialization settings on the parallel I/O.

2-3 PROFIBUS cable connections

PROFIBUS cable connections require a 9-pin D-sub connector with pin assignments as shown in the table below.

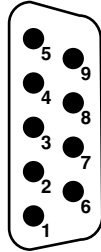

Pin No.	Signal	Meaning
1	—	—
2	—	—
3	RxD/TxD-P	Signal in line A
4	RTS	
5	GND	
6	5V	
7	—	—
8	RxD/TxD-N	Signal in line B
9	—	—

PROFIBUS-DP connector

Plug the bus connector on the PROFIBUS cable into this connector.

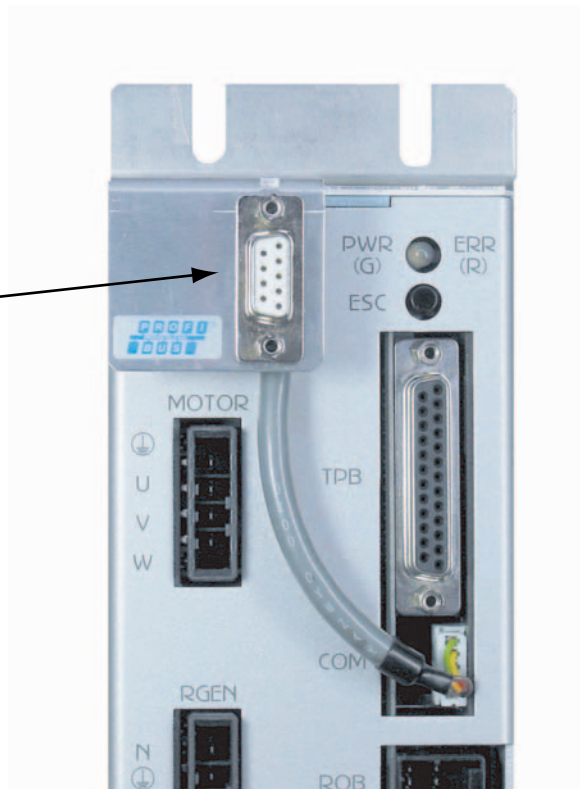

CAUTION

When wiring the bus connector, always follow the manufacturer's instructions to avoid miswiring.

After plugging in the bus connector, be sure to tighten the screws to prevent the connector from coming off.

2-4 Parallel I/O connector

The I/O connector must be wired into the controller so install as shown below even if not using the controller's parallel I/O.

■ When the ERCX/SRCX/DRCX series controllers are used:

1. Short Pin No. A-24 (EMG 1) and B-24 (EMG 2).
2. Short Pin No. B-4 (LOCK) and A-15, to B-15 (0V).
3. Connect an external 24 volts to Pin No. A-13, B-13 (+IN COM).
(On DRCX and SRCX you can connect to A-14, B-14 (+24V) and to A-13, B-13 (+IN COM) instead of connecting to an external 24 volt supply.

If Step 1 is not completed, an emergency stop will occur. If Step 2 is not completed, an interlock will be applied. In either case, the controller cannot be operated (see Chapter 4).

Note that 24 volt power will not be supplied to the I/O circuit unless shorted as in 3. An alarm is issued (06:24V POWER OFF) when power is not supplied and the operation disabled.

Please refer to "I/O Interface" in the controller instruction manual for detailed information on parallel I/O operation.

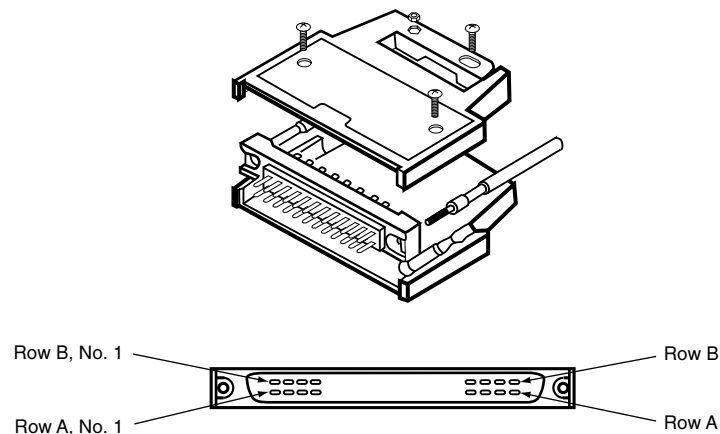

The register in the PROFIBUS unit has an emergency stop input however this is just for control by the software and is not by itself totally adequate. So installing an interlock circuit for emergency stop using the above mentioned A-24 (EMG1) and B-24 (EMG2) is recommended.

■ **When the SRCP/SRCD series is used:**

1. Short Pin No. 1 (EMG 1) and Pin No. 2 (EMG 2) of the EXT.CN connector.
2. Short Pin No. B-4 (LOCK) of the I/O.CN connector and Pin No. 4 (24G) of the EXT.CN connector.
(This wiring can be eliminated by disabling bit 6 (Interlock function setting) of PRM34 (System mode selection).)
3. Connect Pin No. 3 (24V) and Pin No. 4 (24G) of the EXT.CN connector to an external 24 volt supply.

If Step 1 is not completed, an emergency stop will occur. If Step 2 is not completed, an interlock will be activated. The robot cannot move in either case. Also note that 24 volt power will not be supplied to the I/O circuit unless connected as in Step 3. An alarm is issued (06:24V POWER OFF) and the operation is disabled.

Refer to “I/O Interface” in the controller user's manual for detailed information on parallel I/O operation.

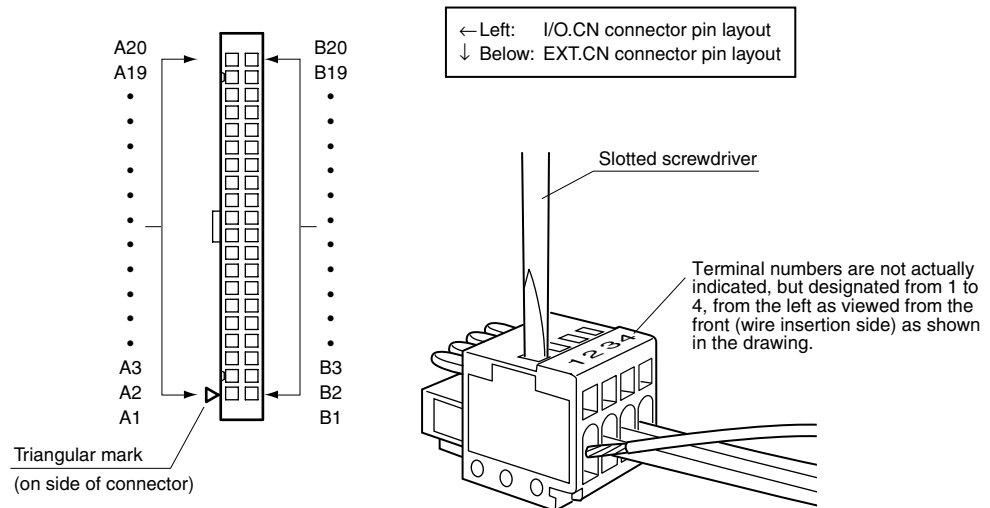

The register in the PROFIBUS unit has an emergency stop input. However, this is just for control by the software and is not by itself totally adequate. So installing an interlock circuit for emergency stop using the above mentioned Pin No.1 (EMG1) and Pin No. 2 (EMG2) of the EXT.CN connector is strongly recommended.

2-5 Controller (slave station) system setting

The station address must be set so that the controller can be correctly identified as a slave station on the PROFIBUS system. Communication speed is automatically recognized. The PROFIBUS unit station address is set from the HPB. This setting is enabled after the controller is restarted.

2-5-1 Validating the PROFIBUS unit

Before the PROFIBUS unit can be used, it must first be set as follows, to allow it to be identified by the controller.

- 1) Press **F3** (SYS) on the initial screen.

```
[MENU]
select menu

1EDIT 2OPRT 3SYS 4MON
```

- 2) Press **F4** (next) to switch to the function display and then press **F2** (OPT).

```
[SYS]
select menu

1SAFE 2OPT 3UTL 4next
```

- 3) Press **F1** (DEV).

```
[SYS-OPT]
select menu

1DEV 2NODE 3SPD 4next
```

- 4) The current PROFIBUS unit identity status appears on the display. Now, using the number key pad, enter a 1 to make the PROFIBUS unit identifiable from the controller or enter a 0 to prevent it being identified from the controller, and then press the **⇒** key.

```
[SYS-OPT-DEV]
PROFIBUS= 0
0:invalid 1:valid
```

- 5) When entry is finished, the screen returns to 4).

```
[SYS-OPT-DEV]
PROFIBUS= 1
0:invalid 1:valid
```

2-5-2 Setting the station address

The station address can be set from 0 to 126.

- 1) Press **F3** (SYS) on the initial screen.
- 2) Press **F4** (next) to switch to the function display and then press **F2** (OPT).
- 3) Press **F2** (NODE).
- 4) The currently set station address is displayed. To change this setting, enter the new station address with the number pad keys, and then press the **↵** key.
- 5) When entry is finished, the screen returns to 4).

```
[MENU]
select menu

1EDIT2OPRT3SYS 4MON
```

```
[SYS]
select menu

1SAFE2OPT 3UTL 4next
```

```
[SYS-OPT]
select menu

1DEV 2NODE3SPD 4next
```

```
[SYS-OPT-NODE]
address = 30
range 0→126
```

```
[SYS-OPT-NODE]
address = 1
range 0→126
```

2-5-3 Checking the communication speed

Communication speed is automatically recognized as any of 9.6K, 19.2K, 93.75K, 187.5K, 500K, 1.5M, 3M, 6M and 12M in units of bps.

- 1) Press **F3** (SYS) on the initial screen.

```
[MENU]
select menu

1EDIT2OPRT3SYS 4MON
```

- 2) Press **F4** (next) to switch to the function display and then press **F2** (OPT).

```
[SYS]
select menu

1SAFE2OPT 3UTL 4next
```

- 3) Press **F3** (SPD).

```
[SYS-OPT]
select menu

1DEV 2NODE3SPD 4next
```

- 4) The currently set communication speed is displayed.
To return to the previous screen, press the **ESC** key.

```
[SYS-OPT-SPD]
speed = 12M [bps]
```

2-6 Sequencer (master station) settings

The master station sequencer (or PLC) in the PROFIBUS system can make line tests on the slave station. Use this function to check whether or not the controller is identified as a slave station on the PROFIBUS system before starting any actual work. Refer to the instruction manual for the master station sequencer (PLC) for detailed information.

2-6-1 Exchanging data with the controller

To ensure that data is exchanged correctly and safely between the master station PLC and controller, create a PLC program for the master station that takes the following points into account.

- Put network status information into the PLC program as input conditions to help it handle problems in the network itself. (See the master PLC instruction manual for ways to enter status information.)
- When a network error is detected on the controller, the controller stops operating and turns the servo off. Also all I/O input from the PROFIBUS are recognized as being off during the error. The I/O inputs are automatically restored as the network recovers from the error but the servo remains turned off. So to restore operation, [Emergency stop must be canceled and the servo restore command (SERVO) must be run.
- The controller always keeps the servo off right after its power is turned on. To operate the robot, cancel emergency stop and run the servo restore command (SERVO).
- The controller is resetting (initializing) itself immediately after the controller power is turned on, so do not perform communications right away. The END output turns on when the controller starts up normally and communication is allowed, so first check that the END output is on before inputting commands to the controller. (See "2-8-1 Right after controller power turns on".)

2-7 I/O information

On/off (I/O) information handled by the PROFIBUS unit consists of 16 dedicated inputs, 32 general-purpose I/O inputs, 16 dedicated outputs and 32 general-purpose outputs.

Dedicated inputs are sub-grouped by assigned function into 13 dedicated command inputs, interlock, service mode and emergency stop inputs.

- * Some ports are currently reserved for future use and not available for dedicated command input and dedicated outputs.
- * PROFIBUS I/O functions and methods for using them are basically identical to those for the parallel I/O that are a standard feature in the controller.

2-7-1 Profile (I/O signal table)

The following table is a list profiling the PROFIBUS unit.

More detailed information on each signal is listed in “2-7-2 Dedicated command inputs”.

Remote I/O signals (Bit I/O)

OUTPUT (Slave→Master)		INPUT (Master→Slave)	
Address	Signal Name	Address	Signal Name
Im.0	Servo status (SRV-O)	Qn.0	SERVO (servo recovery)
Im.1	(ZONE 0)	Qn.1	INC-PT (move relative point)
Im.2	(ZONE 1)	Qn.2	ABS-PT (move absolute point)
Im.3	(ZONE 2)	Qn.3	STEP-R (step operation)
Im.4	(ZONE 3)	Qn.4	AUTO-R (auto operation)
Im.5	Reserved	Qn.5	RESET
Im.6	Origin return status (ORG-O)	Qn.6	ORG-S (origin return)
Im.7	Reserved	Qn.7	LOCK (interlock)
Im+1.0	Reserved	Qn+1.0	Reserved
Im+1.1	Reserved	Qn+1.1	Reserved
Im+1.2	Reserved	Qn+1.2	Reserved
Im+1.3	Reserved	Qn+1.3	Reserved
Im+1.4	Reserved	Qn+1.4	Reserved
Im+1.5	END	Qn+1.5	Reserved
Im+1.6	BUSY (executing command)	Qn+1.6	SVCE (service mode)
Im+1.7	READY	Qn+1.7	EMG (emergency stop input)
Im+2.0	SO200	Qn+2.0	SI200
Im+2.1	SO201	Qn+2.1	SI201
Im+2.2	SO202	Qn+2.2	SI202
Im+2.3	SO203	Qn+2.3	SI203
Im+2.4	SO204	Qn+2.4	SI204
Im+2.5	SO205	Qn+2.5	SI205
Im+2.6	SO206	Qn+2.6	SI206
Im+2.7	SO207	Qn+2.7	SI207
Im+3.0	SO208	Qn+3.0	SI208
Im+3.1	SO209	Qn+3.1	SI209
Im+3.2	SO210	Qn+3.2	SI210
Im+3.3	SO211	Qn+3.3	SI211
Im+3.4	SO212	Qn+3.4	SI212
Im+3.5	SO213	Qn+3.5	SI213
Im+3.6	SO214	Qn+3.6	SI214
Im+3.7	SO215	Qn+3.7	SI215

OUTPUT (Slave→Master)		INPUT (Master→Slave)	
Address	Signal Name	Address	Signal Name
Im+4.0	SO216	Qn+4.0	SI216
Im+4.1	SO217	Qn+4.1	SI217
Im+4.2	SO218	Qn+4.2	SI218
Im+4.3	SO219	Qn+4.3	SI219
Im+4.4	SO220	Qn+4.4	SI220
Im+4.5	SO221	Qn+4.5	SI221
Im+4.6	SO222	Qn+4.6	SI222
Im+4.7	SO223	Qn+4.7	SI223
Im+5.0	SO224	Qn+5.0	SI224
Im+5.1	SO225	Qn+5.1	SI225
Im+5.2	SO226	Qn+5.2	SI226
Im+5.3	SO227	Qn+5.3	SI227
Im+5.4	SO228	Qn+5.4	SI228
Im+5.5	SO229	Qn+5.5	SI229
Im+5.6	SO230	Qn+5.6	SI230
Im+5.7	SO231	Qn+5.7	SI231
Im+6.0 to Im+7.7	Not Used	Qn+6.0 to Qn+7.7	Not Used

* Use Im.0 to Im+1.7 as dedicated outputs, Im+2.0 to Im+5.7 as general-purpose outputs, Qn.0 to Qn+1.7 as dedicated inputs, and Qn+2.0 to Qn+5.7 as general-purpose inputs.

* Im+6.0 to Im+7.7 and Qn+6.0 to Qn+7.7 are not used.

CAUTION

- The above profile is for cases where the I/O assignment selection parameter is set to "Type 0: Conventional type" when the controller has an I/O assignment function. For information on the profile when the I/O assignment selection parameter is set to another type, refer to "2-9-2 I/O assignment list".
- The zone output is supported by the following controller versions:
 ERCX, SRCX : Ver. 13.50 or later DRCX : Ver. 18.50 or later
 SRCP, SRCD : Ver. 24.00 or later SRCP30 : Ver. 24.30H or later

Remote Register (Word I/O)

OUTPUT (Slave→Master)			INPUT (Master→Slave)		
Address	Description	Default	Address	Description	Default
IWm+8	Status	-	QWn+8	Execution command	0
IWm+10	Reserved	0	QWn+10		
IWm+12	Command response	0	QWn+12	Command option	0
IWm+14					
IWm+16					
IWm+18					
IWm+20					
IWm+22					
			QWn+22		

* For details on the remote register, refer to "2-12 Remote Command".

What each code means:

Codes used above are written on the basis of the digital I/O address designated in a master manufactured by Siemens.

- I : Input address
- Q : Output address
- m, n : Start address assigned by hardware configuration

■ Bit input/output

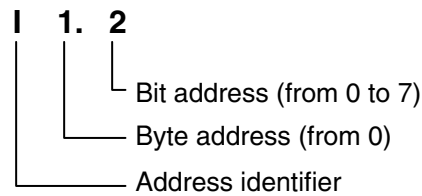

■ Word input/output

QW8																											
QB8							QB9																				
7	6	5	4	3	2	1	0	7	6	5	4	3	2	1	0												
Q8.7							Q8.0							Q9.7							Q9.0						

2-7-2 Dedicated command inputs

Dedicated command inputs are inputs from the sequencer (PLC) to the controller for performing specific processing such as origin return or servo recovery. To accept these inputs, the READY, BUSY, and Lock signals must be set as follows:

- READY : ON
- BUSY : OFF
- LOCK : ON

If the above conditions are not satisfied, then dedicated command inputs cannot be accepted. For example, when the BUSY signal is on, this means that the controller is already executing a dedicated command, so other dedicated commands are ignored if they are input. When the LOCK signal is off, no other commands can be accepted since interlock was triggered.

(As an exception, the reset command is executed if only the BUSY output conditions are met. The servo recovery command is executed if the BUSY conditions are met and all emergency stop inputs to the emergency stop circuit are cancelled.)

A dedicated command input is accepted when the dedicated command input is switched from OFF to ON (at the instant the contact point closes). Whether the controller accepts the command or not can be checked by monitoring the BUSY signal.

Note that dedicated command inputs cannot be used as data in a program.

⚠ CAUTION

The dedicated command inputs explained below must always be pulse inputs. In other words, they must be turned off (contact open) when the BUSY signal turns on.

If a dedicated command input is not turned off, then the BUSY signal will not turn OFF even when the command has ended normally. This means that the next command cannot be accepted.

■ Point movement command with absolute (ABS-PT)

When origin point coordinates are set at 0, this command moves the robot to a position specified in data by point No. (See “2-7-3 General-purpose inputs”) specified by SI200 through SI209, and at a speed specified by SI210 and SI211. On dual-axis controllers, the axis to be moved can be specified with SI213, SI214 by making PRM10 valid.

CAUTION

When executing this command (ABS-PT), the status of SI200 and SI211 must be checked in advance. SI213 and SI214 must also be checked when specifying the axis.

■ Point movement command with incremental (INC-PT)

This command moves the robot from the current position to a position specified in data for point No. specified by SI200 through SI209, and at a speed specified by SI210 and SI211. On dual-axis controllers, the movement axis can be specified with SI213, SI214 by enabling PRM10.

MEMO

Current position is not necessarily the actual position of robot. It is the data of the current position that is saved internally in the controller. On each execution of a movement command, the point that was the target position changes to the current position. Therefore, even if interlock is triggered during execution of the relative movement command, the operation restarts from the point where the robot is stopped, by executing the same relative movement command again. (This does not constitute a relative movement based on the interlock-stopped point.)

Likewise, when the robot is moved manually to another position after executing the robot movement command, the relative movement command which is subsequently executed does not make a relative movement from the actual position of the robot. Instead, the robot makes a relative movement based on the target position of the previous robot movement command. Please bear this movement in mind.

The current position and robot position differ when:

- When emergency stop or interlock (LOCK) is applied during axis movement;
- A communication command “^C” (movement interruption) is sent during axis movement;
- The axis is moved manually; and
- The axis is move manually in the servo off state (including emergency stop state).

CAUTION

SI200 to SI211 status must be checked in advance when running INC-PT. SI213 and SI214 must also be checked when specifying the axis.

■ Automatic run start command (AUTO-R)

The program is run continuously, starting from the current step. All tasks are executed when the multi-task program is running.

■ Step run start command (STEP-R)

The program is run step by step, starting from the current step. The multi-task program only executes the selected task.

■ Origin return command (ORG-S)

This command performs origin return when the search method was selected as the origin detection method, or checks the origin return status if the mark method was selected.

On dual-axis controllers, you can specify the axis for origin return with SI213, SI214 by making PRM10 valid.

MEMO

When performing origin return on a search method axis, if both a mark method axis and a search method axis are present, then origin return must first be completed on the mark method. Mark method origin return is performed on the HPB.

MEMO

Once origin return is performed after the absolute battery and robot cable are connected, it does not have to be performed again, even if the power is turned off. (Exceptions to this are if the absolute battery backup was disabled or origin-point related parameters were changed. Origin point is then incomplete (pending) and must be re-performed.

▲ CAUTION

Do not halt on-going origin return during origin point detection (while contacting the mechanical limits) when using the stroke end origin detection method. A controller overload will trigger an alarm stop condition and the power must be turned off and then on again.

▲ CAUTION

When repeating origin return by the stroke end detection method is unavoidable, wait at least 5 seconds before trying it again.

■ Servo ON command (SERVO)

After an emergency stop, cancel it by releasing the emergency stop switch. This triggers an input to turn the servo power on, and the robot can then resume operation. (The SERVO command is also a pulse input, so must be turned OFF when BUSY turns ON.)

On dual-axis controllers, the servo recovery axis can be specified with S1213, S1214 by making PRM10 valid.

■ Reset command (RESET)

This command returns the program step to the first step of the lead program, and turns DO0 - DO12*¹, SO200 - SO231, and the memory I/O all off. The point variable “P” is also cleared to 0. (Does not clear the counter variables “C” and “D”).

* The output from a parallel I/O port used for emulated serialization does not change even if reset with the RESET command.

* When the “origin return completed action selection” parameter (single-axis controllers: PRM33, dual-axis controllers: PRM2) is 1 or 3, DO4*² does not turn OFF even if reset with the RESET command. In the same way, if the “servo status output selection” parameter (single-axis controllers: PRM46, dual-axis controllers: PRM21) is 1, DO7*³ does not turn OFF even if reset with the RESET command.

MEMO

The lead program is a program selected by switching to the last program run by HPB or POPCOM.

The lead program can also be switched by running the “@SWI” communication command. It can also be switched even when program data is loaded from the memory card.

*1: DO0 to DO4 when the SRCP/SRCD series controllers are used.

*2: DO5 when the DRCX series controllers are used.

*3: DO3 when the SRCP/SRCD series controllers are used.

2-7-3 General-purpose inputs (SI200 - SI231)

General-purpose inputs are inputs freely available to the user for handling as data in the program.

As a special usage method, SI200 - SI209 can specify point numbers, and SI210 - SI211 can specify movement speed during running of ABS-PT or INC-PT point movement commands. As shown in the table below, a binary code should be entered in SI200 - SI209 to specify the point numbers P0 - P999.

The movement speed is 100% when SI210 and SI211 are both OFF. At all other times, the movement speed is specified by parameters.

By making parameter settings, SI213 and SI214 are sometimes used to specify the movement axis.

Specifying a point number

SI No. Point No.	SI209 (2 ⁹)	SI208 (2 ⁸)	SI207 (2 ⁷)	SI206 (2 ⁶)	SI205 (2 ⁵)	SI204 (2 ⁴)	SI203 (2 ³)	SI202 (2 ²)	SI201 (2 ¹)	SI200 (2 ⁰)
P0	OFF	OFF	OFF	OFF	OFF	OFF	OFF	OFF	OFF	OFF
P1	OFF	OFF	OFF	OFF	OFF	OFF	OFF	OFF	OFF	ON
P3	OFF	OFF	OFF	OFF	OFF	OFF	OFF	OFF	ON	ON
P7	OFF	OFF	OFF	OFF	OFF	OFF	OFF	ON	ON	ON
P15	OFF	OFF	OFF	OFF	OFF	OFF	ON	ON	ON	ON
P31	OFF	OFF	OFF	OFF	OFF	ON	ON	ON	ON	ON
P63	OFF	OFF	OFF	OFF	ON	ON	ON	ON	ON	ON
P127	OFF	OFF	OFF	ON	ON	ON	ON	ON	ON	ON
P254	OFF	OFF	ON	ON	ON	ON	ON	ON	ON	OFF
P511	OFF	ON	ON	ON	ON	ON	ON	ON	ON	ON
P999	ON	ON	ON	ON	ON	OFF	OFF	ON	ON	ON

Specifying movement speed

SI211	SI210	Movement speed
OFF	OFF	100%
OFF	ON	PRM5*
ON	OFF	PRM6*
ON	ON	PRM7*

Specifying the movement axis (For dual-axis controllers)

SI214	SI213	Movement axis
OFF	OFF	All axes
OFF	ON	X axis
ON	OFF	Y axis
ON	ON	All axes

* For dual-axis controllers. For single-axis controllers, the speed is set in order from the top, by PRM41, PRM42, PRM43.

MEMO

The above tables are for cases where the I/O assignment selection parameter is set to "Type 0: Conventional type" when the controller has an I/O assignment function. For examples of specifying each item when the I/O assignment selection parameter is set to another type, refer to "2-9-4 I/O signal description".

2-7-4 Interlock (LOCK)

These are inputs to temporarily stop robot movement.

Robot operation can be stopped by setting this input to OFF during running of dedicated commands from the I/O, during running of a program by HPB (or personal computer), or during return to origin. (Of course, the program operation also stops.)

When this input is OFF however, dedicated commands from the I/O and running of programs from the HPB (or personal computer) as well as origin return are all disabled. Therefore you should normally keep this input at ON.

The only exceptions to this, are the RESET and SERVO commands whose inputs are enabled regardless of whether this interlock input is ON or OFF.

Once the interlock is set to OFF, the robot remains stopped until another command is input (AUTO-R, ORG-S) even if the interlock is set to ON again.

MEMO

The interlock input on the parallel I/O of the controller is also always valid. Accordingly, the interlock will be activated to prevent the automatic operation and others if either of two interlock inputs is OFF. For automatic operation and others, it is necessary to surely keep both interlock inputs ON. (On the SRCP/SRCD series, the parallel I/O interlock can be disabled by the parameter setting. For more details, refer to "2-4 Parallel I/O connector".)

2-7-5 Emergency stop input (EMG)

Use this EMG input when you want to set the robot to emergency stop. Setting this input to OFF cuts off the servo power and turns off the servo.

To restart operation, first set this input to ON, then input the servo recovery command (SERVO) after checking that the READY output is ON. The servo turns ON and the robot can now be operated.

When the HPB (or personal computer) is connected, you can reset from emergency stop by the HPB (or personal computer) operation.

The emergency stop input in the PROFIBUS unit is only controlled by the software and does not constitute a complete safety circuit. So installing a hardware interlock circuit for emergency stop utilizing the emergency stop input pins installed on the parallel I/O of the controller is strongly recommended.

2-7-6 Service mode (SVCE)

This input is valid when the service mode function of the controller main body is valid. The service mode input is used to inform the controller whether the current status is the service mode status or not. In the service mode status, keep this input OFF (the contact is open.).

MEMO

When the status of the service mode input varies during robot operation, the operation execution will be interrupted.

MEMO

When the service mode function is valid, DI15* on the parallel I/O also functions as the service mode input. Accordingly, it will be switched to the service mode status if either of two service mode inputs is merely turned OFF. To escape from the service mode status, it is necessary to turn ON both service mode inputs.

* DI7 when the SRCP/SRCD series controllers are used.

2-7-7 Dedicated outputs

Dedicated outputs inform the sequencer (PLC) of controller status.

■ "Preparation completed" output (READY)

The dedicated output is ON while the controller system is operating normally. However the output turns OFF under any of the following conditions and the motor becomes "free".

- During emergency stop

The READY output turns ON again when emergency stop is canceled. After canceling emergency stop, operation can be restarted by inputting the servo recovery command (SERVO).

- During alarm

If the READY signal is OFF but the robot is not in emergency stop, then some kind of alarm was issued. In this case, operation cannot resume unless the power is turned off and then on again.

■ "Command execution in progress" output (BUSY)

The BUSY signal is ON during execution of a dedicated command input, or execution of a command from the HPB (or personal computer). This signal turns ON when the dedicated input signal is received, so turn dedicated input signal OFF when the BUSY signal turns ON. The BUSY output turns OFF when the executing of this command is ended. (However, all the dedicated inputs must be OFF at this time.)

CAUTION

Always input the dedicated command input as a pulse signal. If this input stays ON, the BUSY signal cannot be turned OFF even if finished executing the command. If the BUSY output is at ON, then the controller cannot accept dedicated inputs and commands from the HPB (or personal computer). Do not try to operate the HPB while the I/O interface is controlling the controller. (This could cause communication errors with the sequencer (PLC) or cause communication error to occur in the HPB.

■ "Execution ended" output (END)

This signal turns OFF when a dedicated command input is received, and then turns ON when the command ends normally. When an error occurs during execution of a command or when an interlock or emergency stop has triggered, the END signal remains unchanged at OFF.

CAUTION

When the RESET command or a movement command for only a small movement is run, the time for running the command (in other words the interval that the END signal is OFF) is extremely short. (Sometimes less than 1ms.) The END signal will not change during operation from the HPB (or personal computer).

MEMO

By changing the System mode selection parameter setting (single-axis controllers: PRM34, dual-axis controllers: PRM20), the execution result of a dedicated command can be output to the END signal at the time when the dedicated command input has turned OFF after the command execution.

For details on the System mode selection parameter, refer to "Description of each parameter" in the controller user's manual.

■ "Servo status" output (SRV-O)

Displays the robot servo status.

This turns ON when all axes are at servo-ON. However, this output is OFF if even just one axis is in servo-OFF status.

* This servo status output is always enabled, even if the "servo status output selection" parameter (single-axis controllers: PRM46, dual-axis controllers: PRM21) does not have to be changed.

■ "Origin return status" output (ORG-O)

This outputs the robot origin return status.

This output is ON when origin return is complete on all axes. This output however turns OFF if even origin return on even just one axis is incomplete.

* This output is always enabled, even if the "origin return completed action selection" parameter (single-axis controllers: PRM33, dual-axis controllers: PRM2) does not have to be changed.

■ Zone output (ZONE0 to ZONE3)

This specifies the output destination of the zone output function.

The zone output is used to control the signal output when the robot's current position is within the specified range.

To use the zone output function, the desired zone output must be enabled by the Zone output selection parameter (single-axis controllers: PRM53, dual-axis controllers: PRM24). This parameter also sets the zone output logic.

Use point data to specify the range. Point numbers and output signal names used for each zone are shown below.

For details on the zone output, refer to the "Zone output selection" parameter described in the controller user's manual.

Setting range and output port for each zone

ZONE No.	Specified range	Output signal name
ZONE 0	P900-P901	ZONE 0
ZONE 1	P902-P903	ZONE 1
ZONE 2	P904-P905	ZONE 2
ZONE 3	P906-P907	ZONE 3

MEMO

The zone output is supported by the following controller versions:

ERCX, SRCX : Ver. 13.50 or later DRCX : Ver. 18.50 or later
 SRCP, SRCD : Ver. 24.00 or later SRCP30 : Ver. 24.30H or later

2-7-8 General-purpose outputs (SO200 - SO231)

These are outputs available to the user and can be freely turned on and off within the program. All general-purpose outputs are reset (OFF) when the power is turned on or when the program is reset.

* A parallel I/O port used for emulated serialization cannot be controlled while a program is running. Also, the output from a parallel I/O port used for emulated serialization does not change even if reset with the RESET command.

2-8 Timing chart

Timing charts are included so please refer to them when creating a sequencer (PLC) program.



2-8-1 Right after controller power turns on

Normal startup

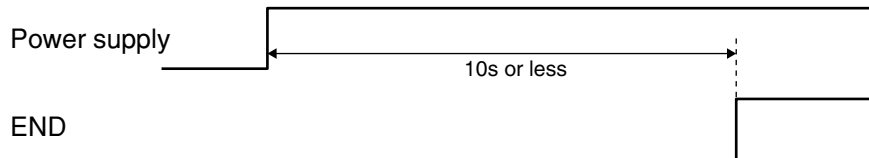

When alarm has occurred

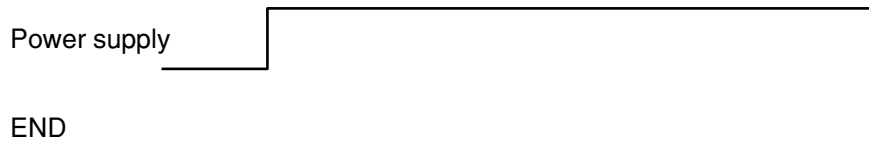

- After power is turned on, the END output turns on when the controller has started up normally and communication is allowed. So first check that the END output is on before inputting commands.
- The controller always sets to servo-off when the controller power is turned on. To operate the robot, cancel emergency stop by referring to “2-8-2 Dedicated input command execution” and then run the SERVO (servo recovery) command.
- When the END output is off even after the specified amount has elapsed after power-on, this means that communication is impossible due to a network error or that an alarm was issued on the controller. To troubleshoot an alarm that occurred on the controller, refer to “Alarm and Countermeasures” in the controller instruction manual.

2-8-2 Dedicated input command execution

- The BUSY output turns ON when a dedicated command input is received. Whether or not the received command ended normally is checked by the END output at the point when the BUSY output turns OFF. In other words, the END output that is ON at this time, shows the command ended normally. However the command did not end normally if the END output is OFF.
- Always input the dedicated command input as a pulse signal. If this input stays on, the BUSY signal cannot turn OFF even if the command is complete.

(1) When a long execution time command runs and ends normally:

(The command execution is in progress and the END signal off when the dedicated command input turns off (contact open))

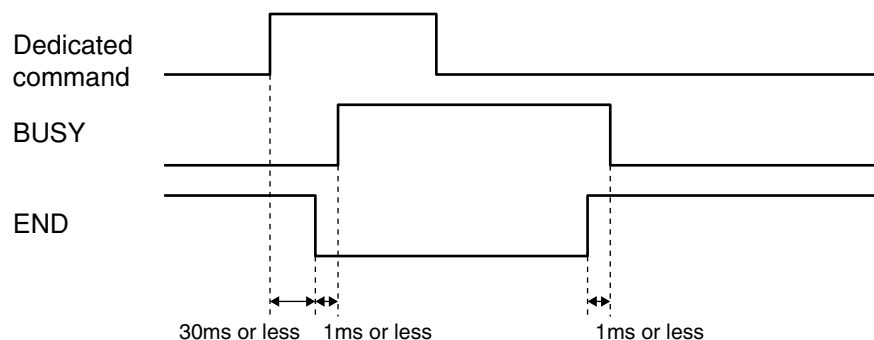

- (1) At the rise of the dedicated command input, the END signal turns off and the BUSY signal turns on.
- (2) Turns off the dedicated command input after the BUSY signal turns on.
- (3) Wait until the BUSY signal turns off.
- (4) The END signal should be on when the BUSY signal turns off, indicating that the command has ended normally.

CAUTION

With the auto run (AUTO-R) command, the END signal turns on and the BUSY signal turns off when the program has ended or a STOP statement was executed. When an endless program (one that always automatically returns to the top line of the program from the last step) was run, the BUSY signal does not turn off unless an interlock or emergency stop is triggered.

(2) When a short execution time command runs and ends normally

(In the following cases, when the dedicated command input is turned OFF, the command has already ended, and END has turned ON.)

- When running a movement command (ABS-PT, INC-PT) with an extremely short movement distance.
- When RESET was run.
- When running steps of a command having an extremely short processing time such as L or DO statements.

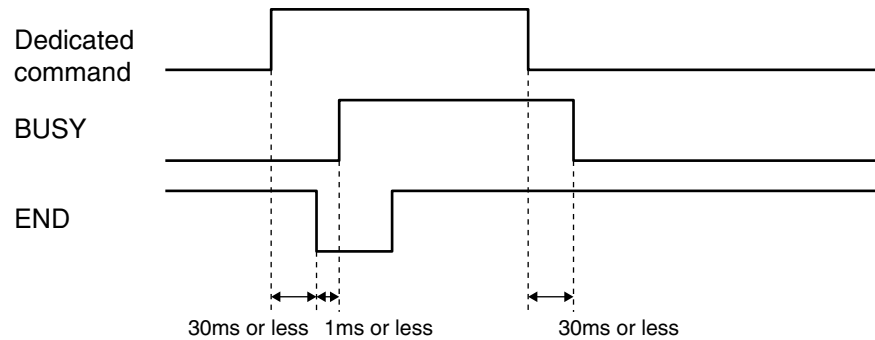

- (1) At the rise of the dedicated command input, the END signal turns off and the BUSY signal turns on.
- (2) Turns off the dedicated command input after the BUSY signal turns on.
- (3) Wait until the BUSY signal turns off. (The BUSY signal immediately turns off since the command execution time is short.)
- (4) The END signal should be on when the BUSY signal turns off, indicating that the command has ended normally.

The "bit 7 END output sequence setting at command execution completion" in the System mode selection parameter (single-axis controllers: PRM34, dual-axis controllers: PRM20) can be changed so that the END signal turns ON when the dedicated command input turns OFF.

MEMO

The "bit 7 END output sequence setting at command execution completion" in the System mode selection parameter (single-axis controllers: PRM34, dual-axis controllers: PRM20) is supported by the following controller versions:

ERCX, SRCX	: Ver. 13.74 or later	DRCX	: Ver. 18.74 or later
SRCP, SRCD	: Ver. 24.32 or later	SRCP30	: Ver. 24.32H or later

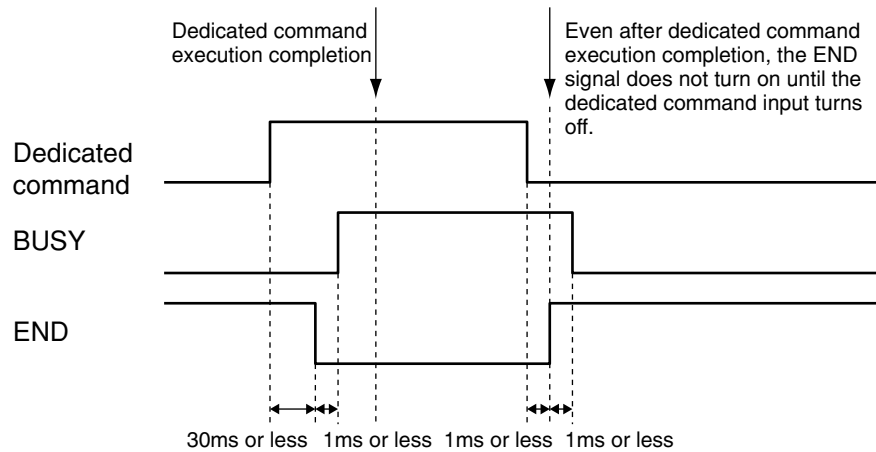

(3) When running a command was impossible from the start

(In the following cases, END will not turn ON, when running of command was impossible from the start.)

- When a movement command (ABS-PT, INC-PT) was run without first completing return to origin.
- When an operation start command (AUTO-R, STEP-R) was run without first completing return to origin (except when pre-operation selection parameter (single-axis controllers: PRM48, dual-axis controllers: PRM9) was set to 1 or 3).
- When an unregistered point No. was specified, and a movement command (ABS-PT, INC-PT) was run.
- When a dedicated command was run while in emergency stop or an interlock triggered. (except for RESET and SERVO commands)

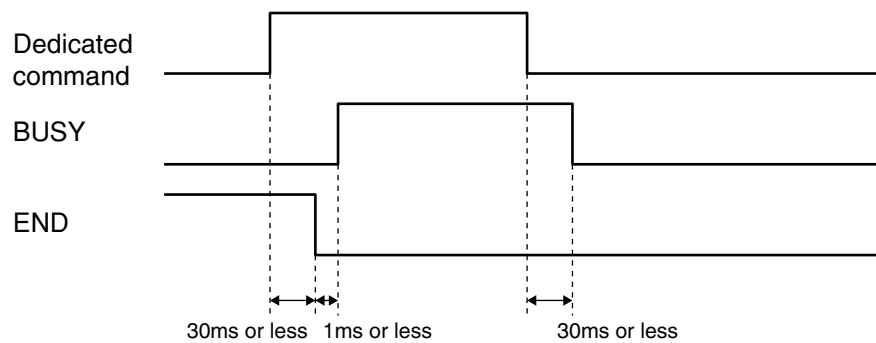

- (1) At the rise of the dedicated command input, the END signal turns off and the BUSY signal turns on.
- (2) Turns off the dedicated command input after the BUSY signal turns on.
- (3) Wait until the BUSY signal turns off. (The BUSY signal immediately turns off since the command cannot be executed.)
- (4) The END signal remains off when the BUSY signal turns off, indicating that the command could not end normally.

(4) When an on-going command becomes impossible to run

(In the following cases, END will not turn ON, when running of an on-going command becomes impossible.)

- When an interlock or emergency stop was triggered during running of a dedicated command.
- When a jump to an unregistered program was made during automatic operation, a move to an unregistered point was made or some kind of error occurred.

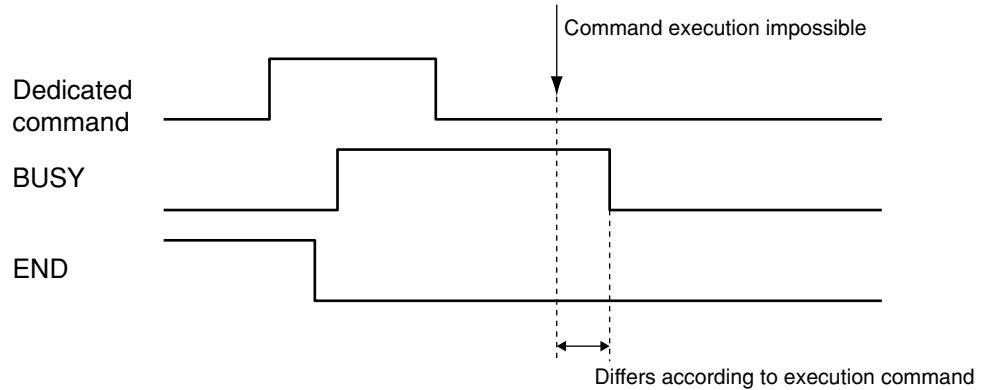

- (1) At the rise of the dedicated command input, the END signal turns off and the BUSY signal turns on.
- (2) Turns off (contact open) the dedicated command input after the BUSY signal turns on.
- (3) Wait until the BUSY signal turns off.
- (4) The BUSY signal turns off because the command execution becomes impossible before it is fully executed.
- (5) The END signal remains off when the BUSY signal turns off, indicating that the command could not end normally.

2-8-3 When interlock signal is input

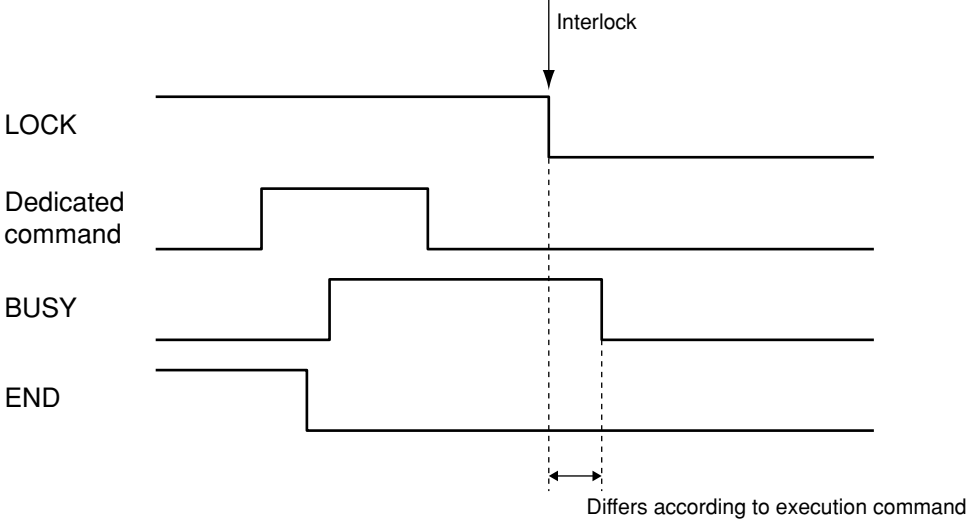

- The BUSY output turns OFF when an interlock signal is input during running of a dedicated command. The READY output and the END output remain unchanged.

2-8-4 When emergency stop signal is input

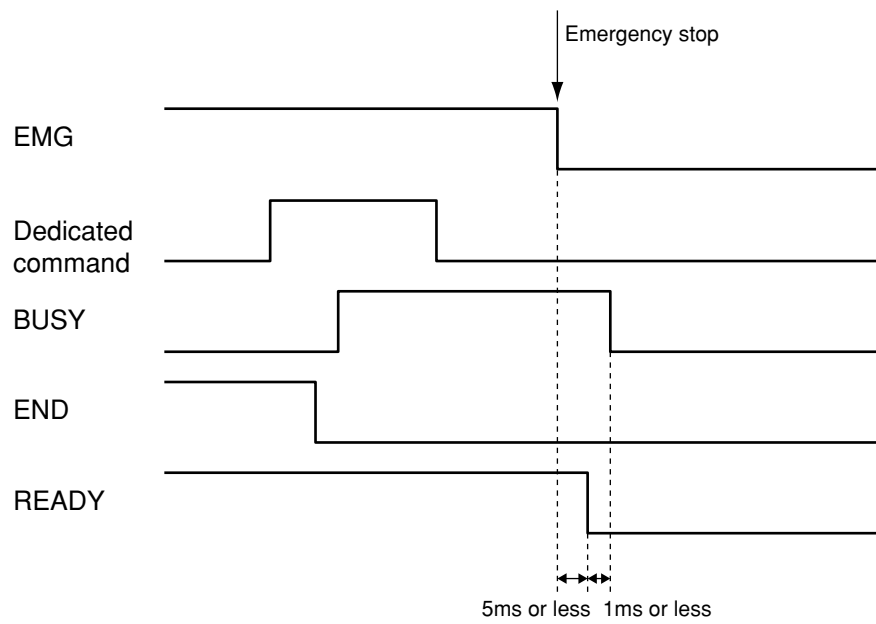

- The READY output turns OFF. The BUSY output turns OFF during running of a dedicated command. The END output is unchanged.
- To resume robot operation, after canceling emergency stop and checking that the READY output is ON, input the SERVO command.

2-8-5 When an alarm is issued

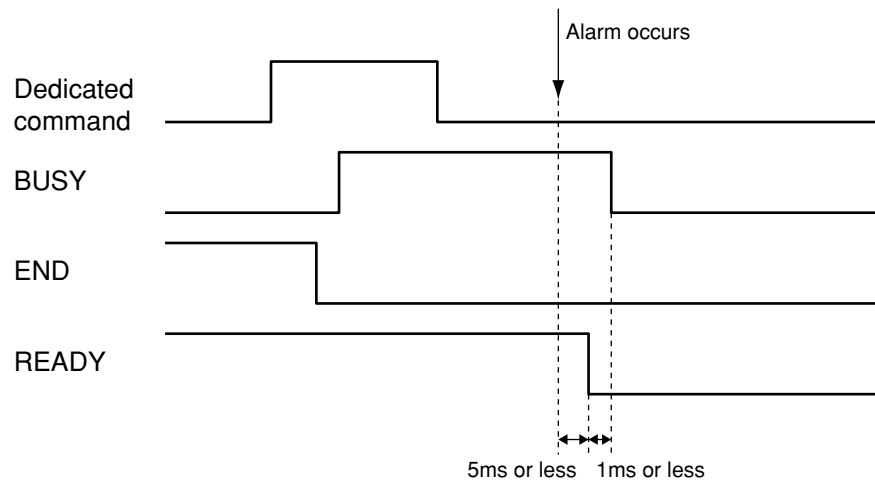

- The READY, BUSY and END outputs all turn off.
- To troubleshoot an alarm that occurred on the controller, refer to “Alarm and Countermeasures” in the controller instruction manual.

2-8-6 When point movement commands are run

- When executing a point movement command (ABS-PT, INC-PT), the point data and speed data must be input before inputting the dedicated command. When specifying the moving axis, the axis selection data must be input. The point data and speed data inputs are designated with SI200 to SI211. The axis selection data input is designated with SI213 to SI214. (Refer to “2-7-3 General-purpose input (SI200 to SI231)”.)

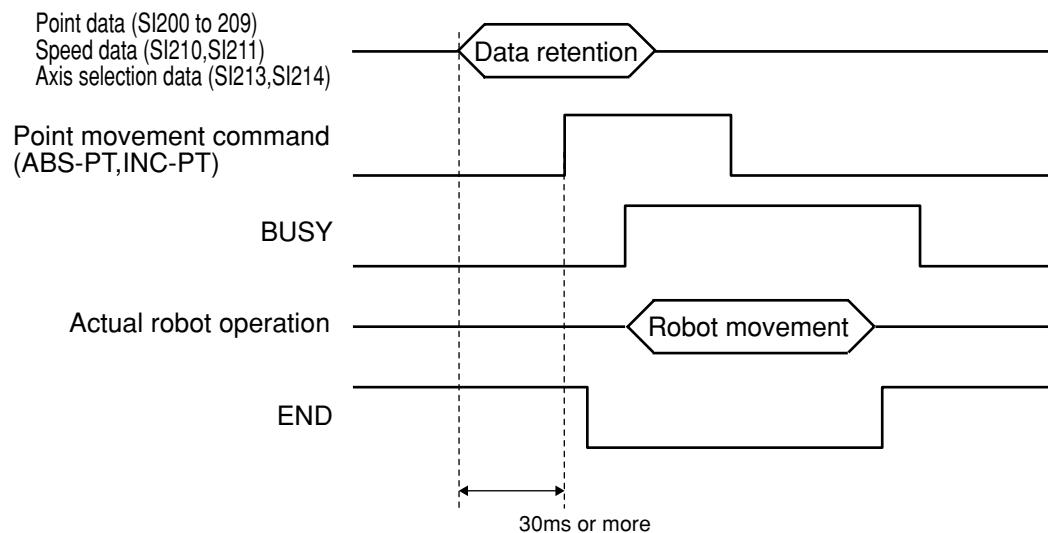

- (1) Input the point and speed data into SI200 - SI211. To specify a movement axis, input the axis (designation) data into SI213, SI214. Please hold this data until the BUSY signal turns on. (Changing data while busy may sometimes cause data recognition errors.)
- (2) Input the point movement commands (ABS-PT, INC-PT) after delaying the time to 30 ms or more.
- (3) The END signal turns off at the rise of the dedicated input pulse, and the BUSY signal turns on.
- (4) After checking that the BUSY is on, the dedicated input command is set to off. From hereon, point data, speed data (SI200 - SI211), and the axis (designation) data (SI213 and SI214) may be changed as needed.
- (5) Waits until the BUSY signal turns off.
- (6) When the BUSY signal has turned off, the END signal is at ON, indicating that the command ended normally.

2-9 I/O assignment change function

2-9-1 Changing the I/O assignment

The I/O assignment change function changes the function assigned to each input/output (I/O) signal.

I/O assignment can be changed by setting the I/O assignment selection parameter (single-axis controllers: PRM59, dual-axis controller: PRM26). For the contents of I/O assignment, refer to "2-9-2 I/O assignment list". Also refer to "2-9-3 I/O assignment selection parameter description" for details on the I/O assignment selection parameter and "2-9-4 Input/output signal description" for details on each input/output signal used for I/O assignment selection. After changing the I/O assignment, the controller must be restarted to enable the changes.

MEMO

The I/O assignment change function is supported by the following controller versions:

ERCX, SRCX	: Ver. 13.57 or later	DRCX	: 18.57 or later
SRCP, SRCD	: Ver. 24.17 or later	SRCP30	: Ver. 24.30H or later

2-9-2 I/O assignment list

The table below shows the function assigned to each input/output (I/O) signal by setting the I/O assignment selection parameter.

For details on the I/O assignment selection parameter, refer to "2-9-3 I/O assignment selection parameter description". For details on each I/O signal, refer to "2-9-4 I/O signal description".

I/O assignment list

Type	Type 0 (Conventional type)	Type 1	Type 2 (Point number output type)		Type 3 (Point teaching type)					
					Point trace mode	Teaching mode	Point trace mode	Teaching mode		
I/O assignment selection parameter	0 (Standard)	—	xx20 *1	xx21 *1	xx30 *1		xx31 *1			
Function										
No. of points *2	1000	—	64	16	64		16			
No. of speed switching points *3	4	—	None	4	None		4			
Program operation by I/O	Yes	—	No	No	No		No			
Address										
Input (Master → Slave)	Qn.0	SERVO	Cannot be used.	SERVO	SERVO	SERVO		SERVO		
	Qn.1	INC-PT		INC-PT	INC-PT	INC-PT	JOG-	INC-PT	JOG-	
	Qn.2	ABS-PT		ABS-PT	ABS-PT	ABS-PT	JOG+	ABS-PT	JOG+	
	Qn.3	STEP-R					CHG		CHG	
	Qn.4	AUTO-R						PSET		PSET
	Qn.5	RESET			RESET	RESET	RESET		RESET	
	Qn.6	ORG-S			ORG-S	ORG-S	ORG-S		ORG-S	
	Qn.7	LOCK			LOCK	LOCK	LOCK		LOCK	
	Qn+1.0									
	Qn+1.1									
	Qn+1.2									
	Qn+1.3									
	Qn+1.4									
	Qn+1.5									
	Qn+1.6	SVCE			SVCE	SVCE	SVCE		SVCE	
	Qn+1.7	EMG			EMG	EMG	EMG		EMG	
	Qn+2.0	SI200			PI200	PI200	PI200		PI200	
	Qn+2.1	SI201			PI201	PI201	PI201		PI201	
	Qn+2.2	SI202			PI202	PI202	PI202		PI202	
	Qn+2.3	SI203			PI203	PI203	PI203		PI203	
	Qn+2.4	SI204			PI204	SPD201	PI204		SPD201	
	Qn+2.5	SI205			PI205	SPD202	PI205		SPD202	
	Qn+2.6	SI206								
	Qn+2.7	SI207								
	Qn+3.0	SI208								
	Qn+3.1	SI209								
	Qn+3.2	SI210								
	Qn+3.3	SI211								
	Qn+3.4	SI212								
	Qn+3.5	SI213 *4			*4	*4	*4		*4	
	Qn+3.6	SI214 *4			*4	*4	*4		*4	
	Qn+3.7	SI215								
Qn+4.0 to Qn+5.7	SI216 to SI231									

(continued to next page)

Output (Slave → Master)	Im.0	SRV-O	Cannot be used.	SRV-O	SRV-O	SRV-O	SRV-O
	Im.1	(ZONE0)		(ZONE0)	(ZONE0)	(ZONE0)	(ZONE0)
	Im.2	(ZONE1)		(ZONE1)	(ZONE1)	(ZONE1)	(ZONE1)
	Im.3	(ZONE2)		(ZONE2)	(ZONE2)	(ZONE2)	(ZONE2)
	Im.4	(ZONE3)		(ZONE3)	(ZONE3)	(ZONE3)	(ZONE3)
	Im.5						
	Im.6	ORG-O		ORG-O	ORG-O	ORG-O	ORG-O
	Im.7						
	Im+1.0						
	Im+1.1						
	Im+1.2						
	Im+1.3						
	Im+1.4						
	Im+1.5	END		END	END	END	END
	Im+1.6	BUSY		BUSY	BUSY	BUSY	BUSY
	Im+1.7	READY		READY	READY	READY	READY
	Im+2.0	SO200		PO200	PO200	PO200	PO200
	Im+2.1	SO201		PO201	PO201	PO201	PO201
	Im+2.2	SO202		PO202	PO202	PO202	PO202
	Im+2.3	SO203		PO203	PO203	PO203	PO203
	Im+2.4	SO204		PO204	ORG-O/ZONE0	PO204	ORG-O/ZONE0
	Im+2.5	SO205		PO205	SRV-O/ZONE1	PO205	SRV-O/ZONE1
	Im+2.6 to Im+3.7	SO206 to SO215					
	Im+4.0 to Im+5.7	SO216 to SO231					

m, n: Start address assigned by hardware configuration

- *1: The PO output format differs depending on the values in the "hundreds" and "thousands" places of the I/O assignment selection parameter (single-axis controllers: PRM59, dual-axis controllers: PRM26).
- *2: Specifies the permissible number of movement points for a point movement command (ABS-PT, INC-PT).
- *3: Specifies the permissible number of speed switching points for a point movement command (ABS-PT, INC-PT).
- *4: In dual-axis controllers, a desired axis can be specified using SI213 and SI214 when executing I/O dedicated commands (ABS-PT, INC-PT, ORG-S, and SERVO). In this case, the PRM10 (control axis selection with I/O command) must first be set to "Valid". The same applies when specifying a control axis for executing JOG movement commands (JOG+, JOG-).

2-9-3 I/O assignment selection parameter description

The I/O assignment selection parameter (single-axis controllers: PRM59, dual-axis controllers: PRM26) selects the function to be assigned to each I/O signal. This parameter setting allows changing the function assigned to each I/O signal. This makes it possible to output the destination point number and perform jog movement. After changing the I/O assignment, the controller must be restarted to enable the changes.

MEMO

The I/O assignment selection parameter is supported by the following controller versions:

ERCX, SRCX : Ver. 13.57 or later DRCX : Ver. 18.57 or later
 SRCP, SRCD : Ver. 24.17 or later SRCP30 : Ver. 24.30H or later

I/O assignment selection parameter

Parameter number Single-axis controllers : PRM59
 Dual-axis controllers : PRM26
 Input range 0 or another number (Refer to "2-9-2 I/O assignment list".)
 Meaning PRM59/PRM26 = $\overset{\textcircled{3}}{\underset{\uparrow}{x}} \overset{\textcircled{2}}{\underset{\uparrow}{x}} \overset{\textcircled{1}}{\underset{\uparrow}{xx}}$

① I/O assignment type selection

Value	Description
00	Type 0 (Conventional type/standard)
20	Type 2 (Point number output type)
21	
30	Type 3 (Point teaching type)
31	

MEMO

Type 1 cannot be used with the SRCP, SRCD, SRCX, SRCX, and DRCX.

② Point output selection

Make setting only for Type 2 (Point number output type) or Type 3 (Point teaching type).

Value	Description
0	Outputs PO when movement ends normally.
1	Outputs PO when movement command is received.
2	Point zone output Outputs PO when the robot enters the ± position judgment parameter range for point data registered in the controller.
3	Movement point zone output Outputs PO when the robot enters the ± position judgment parameter range for point data that is registered in the controller and serves as the movement target position of a point movement command (ABS-PT, INC-PT).

MEMO

The movement point zone output is supported by the following controller versions:

ERCX, SRCX : Ver. 13.64 or later DRCX : Ver. 18.64 or later
 SRCP, SRCD : Ver. 24.21 or later SRCP30 : Ver. 24.30H or later

③ Point zone judgment method selection

The position judgment parameter is selected when the point output selection is "2" (point zone output) or "3" (movement point zone output).

Value	Description
0	OUT valid position
1	Positioning-completed pulse

MEMO

-
- The Point zone judgment method selection is supported by the following controller versions:
 ERCX, SRCX : Ver. 13.64 or later DRCX : Ver. 18.64 or later
 SRCP, SRCD : Ver. 24.21 or later SRCP30 : Ver. 24.30H or later
 - In controller versions prior to the above versions, the "OUT valid position" is the only point zone judgment method.

Initial value 0

CAUTION

Any value other than the above is handled as a "0" (Type 0).

(Example) If set to 2331, this is handled as a "0" (Type 0).

If set to 10, this is handled as a "0" (Type 0).

Moreover, if Type 2 (Point number output type) or Type 3 (Point teaching type) is selected in controller versions not supporting the movement point zone output while the point output selection is specified as "3", this is also processed as a "0" (Type 0) setting.

(Example) In controller versions not supporting the movement point zone output:

If set to 331, this is handled as a "0" (Type 0).

2-9-4 I/O signal description

The meaning of each signal is explained below. For the meaning of signals not described here, refer to "2-7-2 Dedicated command input" and the following sections.

■ Point number designation inputs 200 to 205 (PI200 to PI205)

These inputs designate the point number of the target position where the robot moves with a point movement command (ABS-PT, INC-PT). (For details on the ABS-PT and INC-PT commands, see 2-7-2, "Dedicated command input" in this chapter.)

These inputs are also used to designate the point number of the target position where point data is written with a point data write command (PSET).

The point number of the target position must be specified before running a point movement command or point write command. The point number is specified by a binary code. See the table below to specify each point number.

Point number designation example

PI No. Point No.	PI205 (2 ⁵)	PI204 (2 ⁴)	PI203 (2 ³)	PI202 (2 ²)	PI201 (2 ¹)	PI200 (2 ⁰)
P0	OFF	OFF	OFF	OFF	OFF	OFF
P1	OFF	OFF	OFF	OFF	OFF	ON
P7	OFF	OFF	OFF	ON	ON	ON
P15	OFF	OFF	ON	ON	ON	ON
P31	OFF	ON	ON	ON	ON	ON
P63	ON	ON	ON	ON	ON	ON

■ Movement speed setting (SPD201, SPD202)

Designates the speed at which the robot moves with a point movement command (ABS-PT, INC-PT) or jog movement command (JOG+, JOG-). (For details on the ABS-PT and INC-PT commands, see 2-7-2, "Dedicated command input" in this chapter.)

The movement speed must be specified before running a point movement command or jog movement command. See the table below to specify the movement speed.

Movement speed setting example

SPD202	SPD201	Movement speed
OFF	OFF	100%
OFF	ON	I/O point movement command first speed (single-axis controllers: PRM41, dual-axis controllers: PRM5)
ON	OFF	I/O point movement command second speed (single-axis controllers: PRM42, dual-axis controllers: PRM6)
ON	ON	I/O point movement command third speed (single-axis controllers: PRM43, dual-axis controllers: PRM7)

■ Jog movement (+ direction) command (JOG+)

Moves the robot in jog mode along the + (plus) direction.

The robot moves in jog mode along the + (plus) direction as long as this signal is on. The movement speed is 100mm/sec.

This speed can be changed by using SPD201 and SPD202. In this case, the movement speed is given by the following equation.

$$\text{Movement speed [mm/sec]} = 100 \times (\text{Movement speed [\%] specified with SPD201 and SPD202}) / 100$$

In the case of dual-axis controllers, the X-axis is usually used for jog movement.

However, the Y-axis can be specified with SI213 and SI214 by enabling PRM10 (Control axis selection with I/O command). (Refer to "PRM10: Control axis selection with I/O command" in the DRCX controller user's manual.)

Axis selection example

SI214	SI213	JOG+, JOG- Selected axis
OFF	OFF	X-axis
OFF	ON	X-axis
ON	OFF	Y-axis
ON	ON	X-axis

⚠ CAUTION

- If the CHG (mode switch input) signal is switched during jog movement, the robot comes to an error stop.
- When selecting the axis of a dual-axis controller, the status of SI213 and SI214 must first be determined. (Refer to "Jog movement (JOG+, JOG-)" in "2-9-5 Timing chart".)

■ Jog movement (- direction) command (JOG-)

Moves the robot in jog mode along the - (minus) direction.

The robot moves in jog mode along the - (minus) direction as long as this signal is on. The movement speed is 100mm/sec.

This speed can be changed by using SPD201 and SPD202. In this case, the movement speed is given by the following equation.

$$\text{Movement speed [mm/sec]} = 100 \times (\text{Movement speed [\%] specified with SPD201 and SPD202}) / 100$$

In the case of dual-axis controllers, the X-axis is usually used for jog movement.

However, the Y-axis can be specified with SI213 and SI214 by enabling PRM10 (Control axis selection with I/O command). (Refer to "PRM10: Control axis selection with I/O command" in the DRCX controller user's manual.)

Axis selection example

SI214	SI213	JOG+, JOG- Selected axis
OFF	OFF	X-axis
OFF	ON	X-axis
ON	OFF	Y-axis
ON	ON	X-axis

⚠ CAUTION

- If the CHG (mode switch input) signal is switched during jog movement, the robot comes to an error stop.
- When selecting the axis of a dual-axis controller, the status of SI213 and SI214 must first be determined. (Refer to "Jog movement (JOG+, JOG-)" in "2-9-5 Timing chart".)

■ Mode switch input (CHG)

Switches the Type 3 (Point teaching type) mode. Selectable modes are as follows.

- (1) Point trace mode
- (2) Teaching mode

The Type 3 (Point teaching type) mode is switched to "Point trace mode" when the CHG signal is off, and is switched to "teaching mode" when the CHG signal is on.

⚠ CAUTION

If the CHG signal is switched during execution of a point movement command (ABS-PT, INC-PT) or jog movement command (JOG+, JOG-), the robot comes to an error stop.

■ **Point data write command (PSET)**

Writes the current position data in the specified point number.

To use this command, the point number for writing the current position data must first be specified using a PI (point number designation input) input.

The PSET is enabled only when return-to-origin has been completed.

■ **Target position's point number outputs 200 to 205 (PO200 to PO205)**

These are the output signals for the point movement command (ABS-PT, INC-PT) target position point numbers, and for the point numbers corresponding to the point zone output and movement point zone output functions. (For details on ABS-PT and INC-PT commands, see 2-7-2, "Dedicated command input" in this chapter.)

The "point zone output function" outputs the corresponding point number to the PO when the robot enters the point zone output range (corresponding point \pm position judgment parameter range). The corresponding point of this point zone output range is the point data registered at the controller.

Moreover, the point zone output range's corresponding point can be further narrowed to correspond to point movement commands (ABS-PT, INC-PT), with the point number being output to the PO. This is referred to as the movement point zone output function.

Point zone output function

For single-axis controller

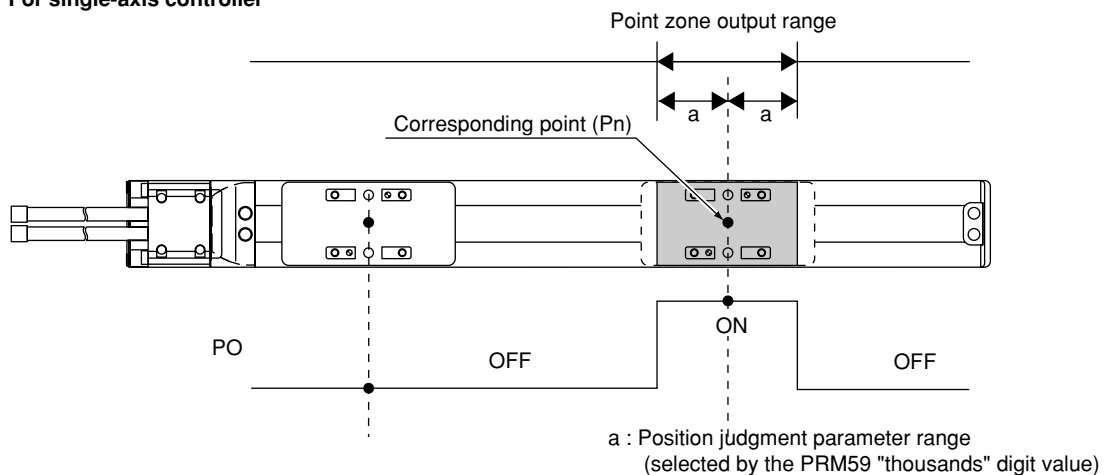

For dual-axis controller

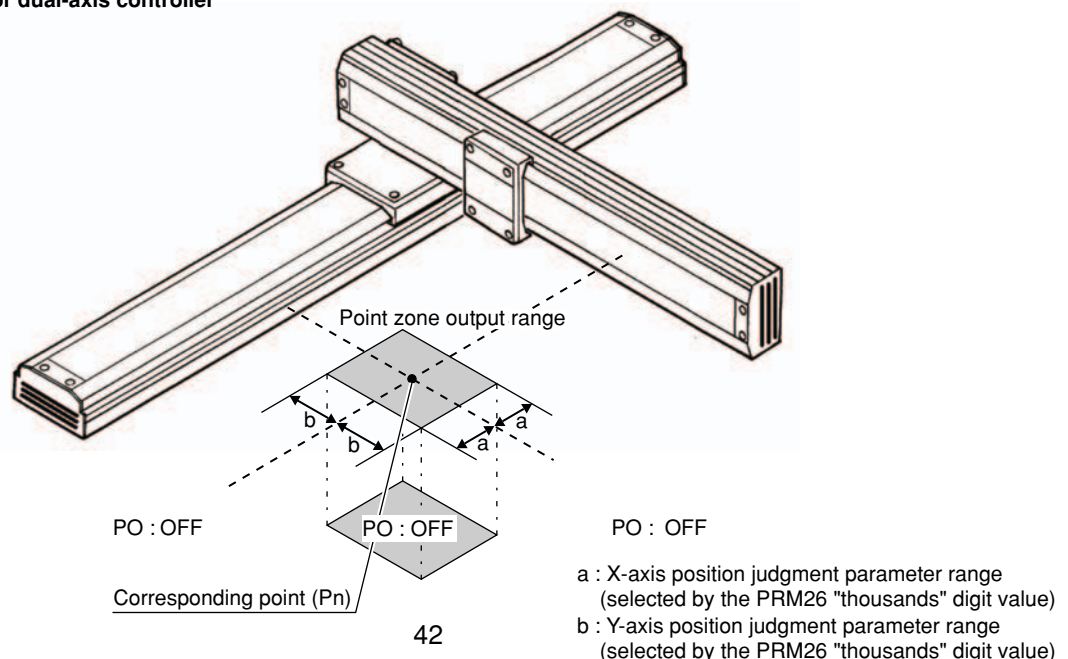

Target position point numbers for point movement commands (ABS-PT, INC-PT) are output as binary values. The same applies to point numbers which correspond to the point zone output function and the movement point zone output function. The PO output format is specified in the "hundreds" place of the I/O assignment selection parameter setting (single-axis controllers: PRM59, dual-axis controllers: PRM26)

- 0: PO output occurs at normal movement completion.
- 1: PO output occurs when movement command is received.
- 2: Point zone output
(PO output occurs when the current position enters the point data (registered at the controller) \pm position judgment parameter range.)
- 3: Movement point zone output
(PO output occurs when the current position enters the point data registered at the controller, and the point movement command's (ABS-PT, INC-PT) movement point data \pm position judgment parameter range.)

MEMO

The movement point zone output function is supported by the following controller versions.

ERCX, SRCX : Ver. 13.64 or later DRCX : Ver. 18.64 or later
 SRCP, SRCD : Ver. 24.21 or later SRCP30 : Ver. 24.30H or later

Output example

PO No. Point No.	PO205 (2 ⁵)	PO204 (2 ⁴)	PO203 (2 ³)	PO202 (2 ²)	PO201 (2 ¹)	PO200 (2 ⁰)
P0	OFF	OFF	OFF	OFF	OFF	OFF
P1	OFF	OFF	OFF	OFF	OFF	ON
P7	OFF	OFF	OFF	ON	ON	ON
P31	OFF	ON	ON	ON	ON	ON
P63	ON	ON	ON	ON	ON	ON

CAUTION

When using PO as an output signal that indicates the target position's point number for point movement commands (ABS-PT, INC-PT):

- If moving the robot to point 0 with at the first point movement command which is executed after turning the controller on, all the PO200 to PO205 signals still remain off (because P0 = 000000_(binary)) even after the robot has moved to point 0. This means that the PO200 to PO205 signal statuses do not change even after the robot has moved to P0, so no information is available to indicate whether the robot motion to P0 is complete (or whether the movement command was received). This should be kept in mind when moving the robot to point 0.

When using PO as an output signal that indicates the corresponding point number at the point zone output function or the movement point zone output function:

- If outputting point 0 (P0) as the corresponding point for the point zone output function or the movement point zone output function, all the PO200 to PO205 signals remain off (because P0 = 000000_(binary)). This means that the PO200 to PO205 signal statuses do not change even after the robot has entered the zone specified by P0. This should be kept in mind when monitoring P0.

MEMO

When using PO as an output signal that indicates the target position's point number for point movement commands (ABS-PT, INC-PT):

- When a point movement is received through a parallel I/O, the target position's point number is output to the corresponding parallel I/O (PO0 to PO5). When received through a serial I/O such as a CC-Link, the target position's point number is output to the corresponding serial I/O (PO200 to PO205).
- All PO outputs are reset (OFF) when a program reset is performed.

When using PO as an output signal that indicates the corresponding point number at the point zone output function:

- The corresponding point number for the point zone output function is output to both the corresponding parallel I/O (PO0 to PO5) and the serial I/O (PO200 to PO205). In the SRCP/SRCD series, however, the point number is only output to the serial I/O.
- All PO outputs are reset (OFF) when a program reset is performed.

When using PO as an output signal that indicates the corresponding point number at the movement point zone output function:

- The corresponding point number for the movement point zone output function is output to both the corresponding parallel I/O (PO0 to PO5) and the serial I/O (PO200 to PO205). In the SRCP/SRCD series, however, the point number is only output to the serial I/O.
- Movement points are reset immediately after a controller power on, and all PO outputs are therefore turned off at that time. Movement points are also reset if a program reset is performed, and the movement point zone PO outputs are reset (OFF) at that time as well.

■ Return-to-origin complete output / Zone output 0 (ORG-O / ZONE0)

This output notifies that return-to-origin operation is complete. When Zone 0 output is enabled with the Zone output selection parameter (single-axis controllers: PRM53, dual-axis controllers: PRM24), the ORG-O output is used as the output port of Zone 0 (ZONE0).

The ORG-O output is an output signal having the same function as address Im.6. For details on the output signal, refer to "Return-to-origin status output (ORG-O)" in "2-7-7 Dedicated output".

The ZONE0 output is an output signal having the same function as address Im.1. For details on the output signal, refer to "Zone output (ZONE0 to ZONE3)" in "2-7-7 Dedicated output" and also to "Zone output selection" described in the controller user's manual.

■ Servo status output / Zone output 1 (SRV-O / ZONE 1)

This is the servo status output. When Zone 1 output is enabled with the Zone output selection parameter (single-axis controllers: PRM53, dual-axis controllers: PRM24), the SRV-O output is used as the output port of Zone 1 (ZONE1).

The SRV-O output is an output signal having the same function as address Im.0. For details on the output signal, refer to "Servo status output (SRV-O)" in "2-7-7 Dedicated output".

The ZONE1 output is an output signal having the same function as address Im.2. For details on the output signal, refer to "Zone output (ZONE0 to ZONE3)" in "2-7-7 Dedicated output" and also to "Zone output selection" described in the controller user's manual.

2-9-5 Timing chart

This section shows timing charts for the operations that are added by changing the I/O assignment.

■ Jog movement (JOG+, JOG-)

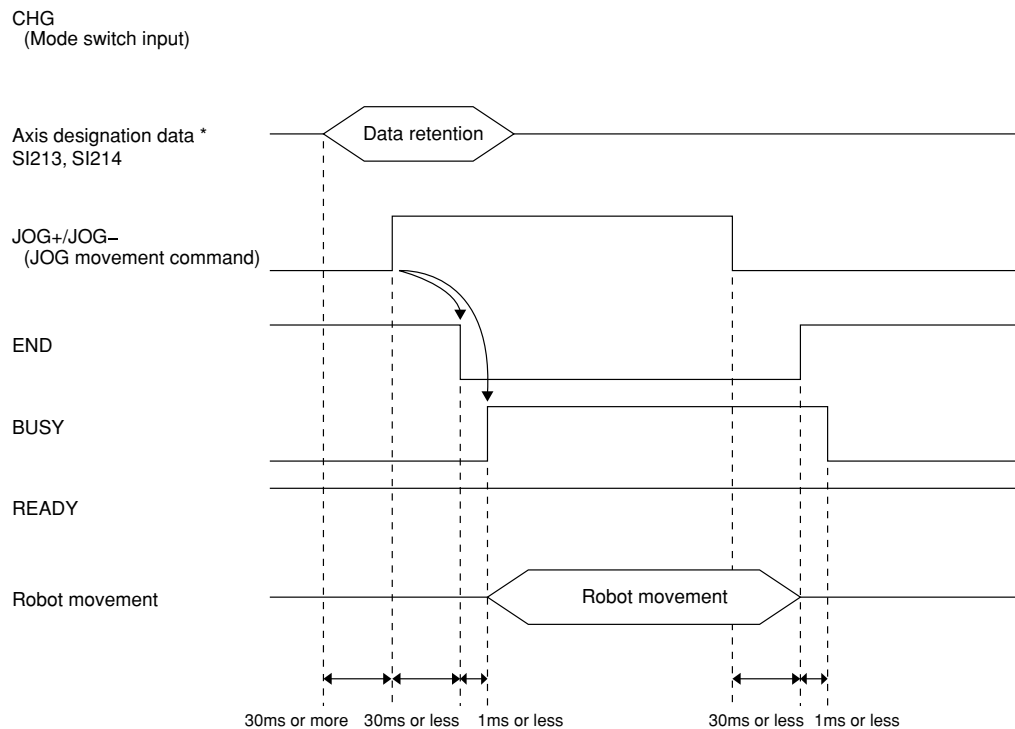

* For dual-axis controllers only. In the case of dual-axis controllers, the X-axis is usually used for jog movement. However, the Y-axis can be specified with SI213 and SI214 by enabling PRM10 (Control axis selection with I/O command).

- (1) Turn on the CHG signal.
- (2) To specify the movement axis by a dual-axis controller, input the axis designation data to SI213 and SI214.
 - The input status specified here must be kept unchanged until step (4) is complete. If this input status is changed, the controller might misrecognize the data.
- (3) Turn on the JOG+ (or JOG-) input signal while the CHG signal is on.
- (4) The END signal turns off and the BUSY signal turns on, indicating that the controller received the jog movement command.
- (5) The robot moves in jog mode as long as the JOG+ (or JOG-) input signal is on.
- (6) Turn off the JOG+ (or JOG-) input signal.
- (7) Wait until the BUSY signal turns off.
- (8) The BUSY signal turns off. The END signal should be on at this point, indicating that the jog movement is normally complete.

⚠ CAUTION

- If the CHG signal is switched during execution of a jog movement command (JOG+, JOG-), the robot comes to an error stop and the END signal remains off.
- When specifying the axis, the SI213 and SI214 status must be checked beforehand. (Refer to "PRM10: Control axis selection with I/O command" in the DRCX controller user's manual.)

■ Point data write (PSET)

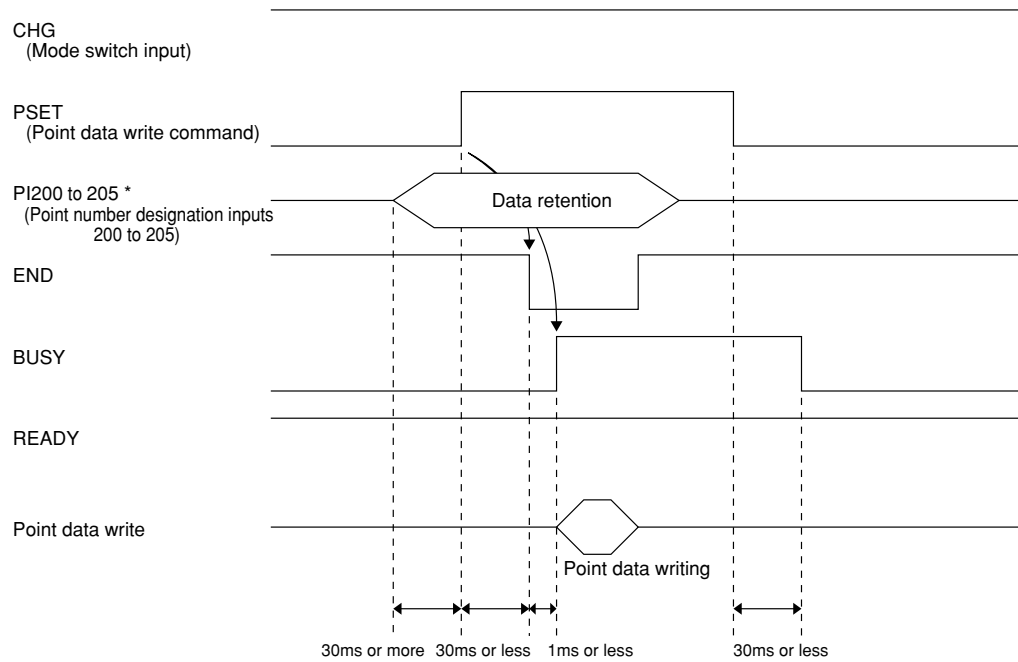

* The number of point number outputs that can be used depends on the I/O assignment type.

Precondition: The CHG signal is on before and during point data writing (until the following procedure is complete).

- (1) Designate the point number input (PI200 to PI205) to write the point data.
 - The point numbers that can be used depend on the I/O assignment type. Refer to the I/O assignment list in “2-9-2 Changing the I/O assignment”.
 - The input status for designating the point number must be kept unchanged until step (3) is complete. If this input status is changed, the controller might misrecognize the data.
- (2) After 30ms or more has elapsed, turn on the PSET.
- (3) The END signal turns off and the BUSY signal turns on, indicating that the controller received the point data write command.
- (4) Turn off the PSET.
- (5) Wait until the BUSY signal turns off.
- (6) The BUSY signal immediately turns off since point data writing is already finished. The END signal should be on at this point, indicating that the point data writing was completed normally.

■ Target position's point number output (PO)

(1) Outputting the point number at the timing that movement is normally completed

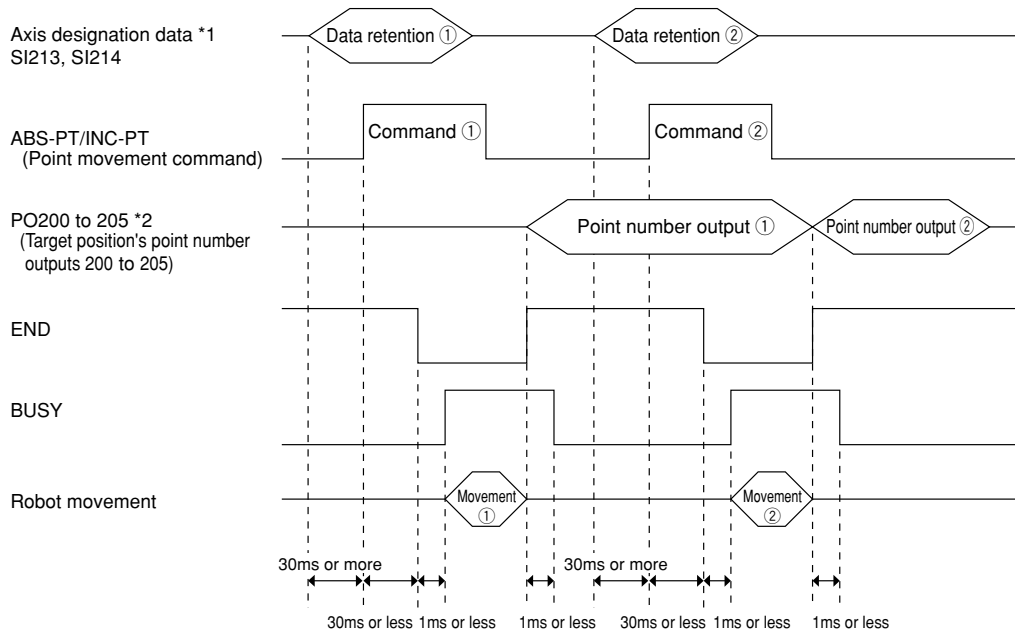

*1 For dual-axis controllers only. In the case of dual-axis controllers, all axes are usually used for movement. However, the desired axis can be specified with SI213 and SI214 by enabling PRM10 (Control axis selection with I/O command).

*2 The number of point number outputs that can be used depends on the I/O assignment type.

Precondition: 1) The following steps are explained assuming that the I/O assignment selection parameter (single-axis controllers: PRM59, dual-axis controllers: PRM26) is set to 30.

When I/O assignment selection parameter = 30 (single-axis controllers: PRM59, dual-axis controllers: PRM26)	
I/O assignment type	Type 3 (point teaching type)
Permissible number of movement points	64 points
Point output selection	Point No. output to PO when movement ends normally

2) The point numbers of the target positions are designated before running a point movement command (ABS-PT, INC-PT).

[Point movement command execution ①]

- (1) To specify the movement axis by a dual-axis controller, input the axis designation data to SI213 and SI214.
 - The input status specified here must be kept unchanged until step (3) is complete. If this input status is changed, the controller might misrecognize the data.
- (2) Turn on the ABS-PT (or INC-PT).
- (3) The END signal turns off and the BUSY signal turns on, indicating that the controller received the point movement command.
- (4) Turn off the ABS-PT (or INC-PT).
- (5) Wait until the BUSY signal turns off.
- (6) The BUSY signal turns off. The END signal should be on at this point, indicating that the point movement is normally finished.
- (7) When the END signal is on in step (6), the target position's point number is output from the specified point number (PO200 to PO205).
 - The output status of the target position's point number is retained until execution of the next point movement command is complete.



[Point movement command execution ②]

- (8) Execute the next point movement command.
- (9) Point movement ends.
- (10) The END signal turns on. The previous target position's point number being output from the specified point number (PO200 to PO205) is cleared and the current target position's point number is then output.

⚠ CAUTION

- If moving the robot to point 0 with a point movement command that is first executed after turning on the controller, all of PO200 to PO205 still remain off (because $P0 = 000000_{(binary)}$) even after the robot has moved to point 0. This means that the PO200 to PO205 status does not change even after the robot has moved to P0, so no information is available to indicate whether the robot motion to P0 is complete (or whether the movement command was received). This should be kept in mind when moving the robot to point 0.
 - When specifying the axis, the SI213 and SI214 status must be checked beforehand. (Refer to "PRM10: Control axis selection with I/O command" in the DRCX controller user's manual.)
-

(2) Outputting the point number at the timing that a movement command is received

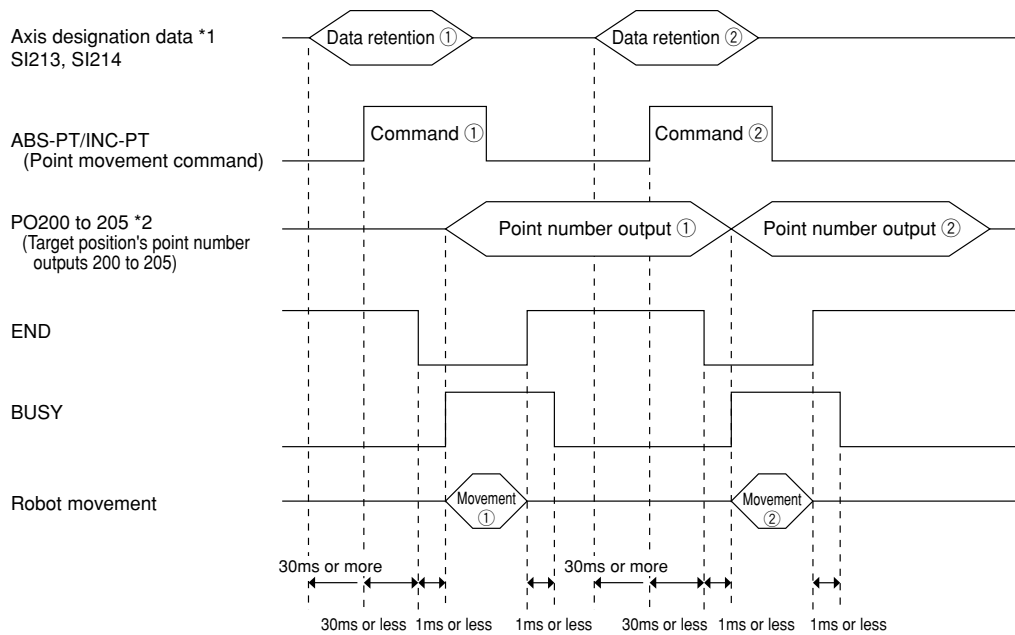

*1 For dual-axis controllers only. In the case of dual-axis controllers, all axes are usually used for movement. However, the desired axis can be specified with SI213 and SI214 by enabling PRM10 (Control axis selection with I/O command).

*2 The number of point number outputs that can be used depends on the I/O assignment type.

Precondition: 1) The following steps are explained assuming that the I/O assignment selection parameter (single-axis controllers: PRM59, dual-axis controllers: PRM26) is set to 130.

When I/O assignment selection parameter = 130 (single-axis controllers: PRM59, dual-axis controllers: PRM26)	
I/O assignment type	Type 3 (point teaching type)
Permissible number of movement points	64 points
Point output selection	Point No. output to PO when movement command is received

2) The point numbers of the target positions are designated before running a point movement command (ABS-PT, INC-PT).

[Point movement command execution ①]

- (1) To specify the movement axis by a dual-axis controller, input the axis designation data to SI213 and SI214.
 - The input status specified here must be kept unchanged until step (3) is complete. If this input status is changed, the controller might misrecognize the data.
- (2) Turn on the ABS-PT (or INC-PT).
- (3) The END signal turns off and the BUSY signal turns on, indicating that the controller received the point movement command.
- (4) When the BUSY signal turns on in step (3), the target position's point number is output from the specified point number (PO200 to PO205).
 - The output status of the target position's point number is retained until the next point movement command is received.
- (5) Turn off the ABS-PT (or INC-PT).
- (6) Wait until the BUSY signal turns off.
- (7) The BUSY signal turns off. The END signal should be on at this point, indicating that the point movement finished normally.



[Point movement command execution ②]

- (8) Execute the next point movement command.
- (9) When the controller received the point movement command and the BUSY signal turned on, the previous target position's point number being output from the specified point number (PO200 to PO205) is cleared and the current target position's point number is then output.

⚠ CAUTION

- If moving the robot to point 0 by specifying it with a point movement command that is first executed after turning on the controller, all of PO200 to PO205 still remain off (because P0 = 000000_(binary)) even after the robot has moved to point 0. This means that the PO200 to PO205 status does not change even after specifying P0 as the target position, so no information is available to indicate whether the movement command to P0 was received. This should be kept in mind when moving the robot to point 0.
 - When specifying the axis, the SI213 and SI214 status must be checked beforehand. (Refer to "PRM10: Control axis selection with I/O command" in the DRCX controller user's manual.)
-

(3) Outputting the corresponding point number by the point zone output function

Zone outputs (ZONE 0, ZONE 1) are also explained here.

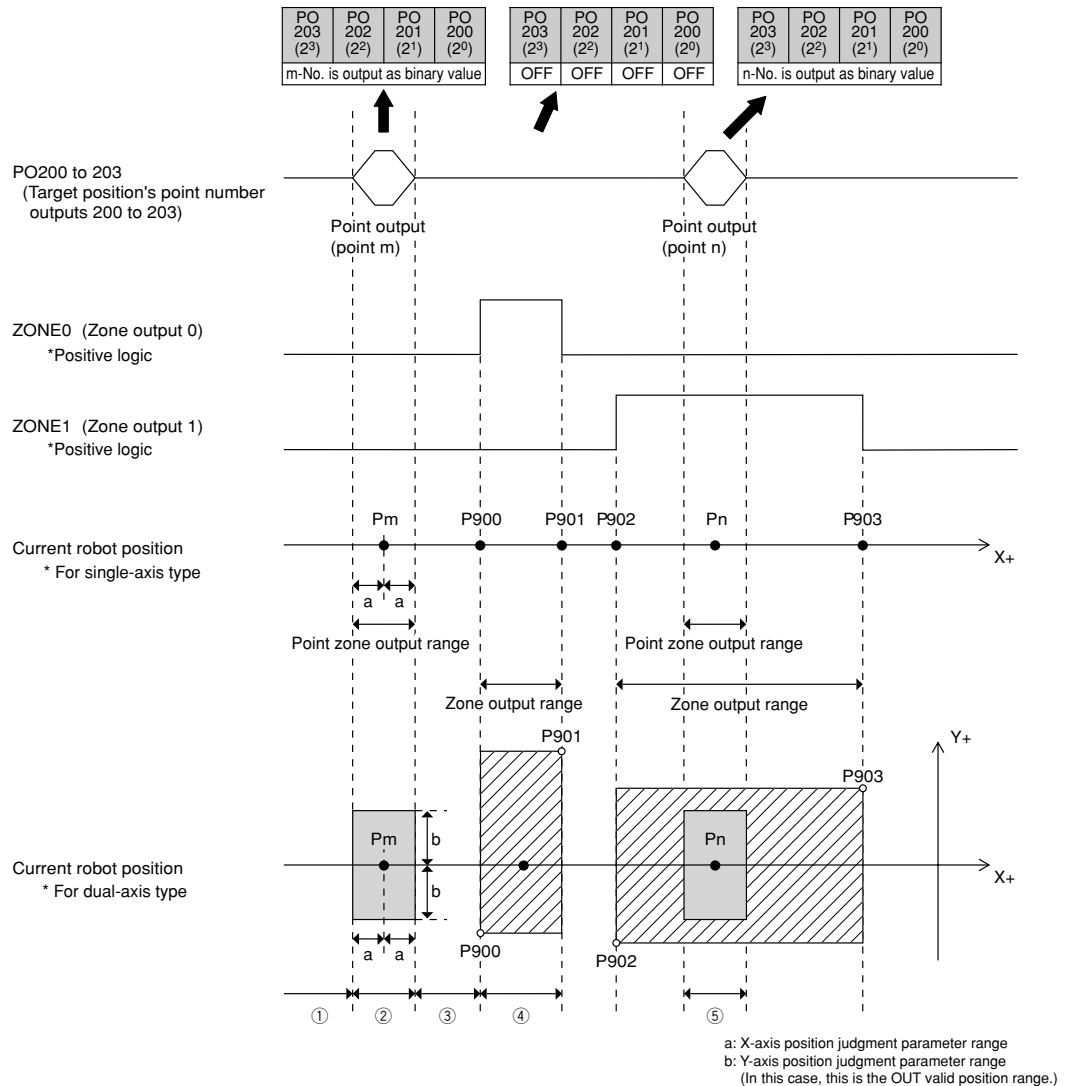

* The number of target point number outputs that can be used depends on I/O assignment type.

Precondition: 1) The following steps are explained assuming that the I/O assignment selection parameter (single-axis controllers: PRM59, dual-axis controllers: PRM26) is set to 221.

When I/O assignment selection parameter = 221 (single-axis controllers: PRM59, dual-axis controllers: PRM26)	
I/O assignment type	Type 2 (Point No. output type)
Permissible number of movement points	16 points
Point output selection	Point zone output
Point zone judgment method (position judgment parameter)	OUT valid position

2) The Zone 0 output and Zone 1 output are enabled and set to positive logic output by the Zone output selection parameter (single-axis controllers: PRM53, dual-axis controllers: PRM24).

(1) Target position's point number outputs PO200 to PO203 are off since the current robot position is not within the point zone output range. ZONE 0 and ZONE 1 output signals are also off since the robot does not yet enter the zone output range.

- (2) Outputs the corresponding point number through PO200 to PO203 since the current robot position is within the point zone output range ($P_m \pm \text{OUT}$ valid position range). ZONE 0 and ZONE 1 output signals are still off since the robot does not yet enter the zone output range.
- (3) As with (1), all the target position's point number outputs PO200 to PO203, ZONE 0 signal and ZONE 1 output signal are off.
- (4) ZONE 0 output signal turns on since the current robot position is within the zone output range (P900 to P901). (ZONE 1 signal remains off since the robot is not within the zone output range of P902 to P903). At this point, the target position's point number outputs PO200 to PO203 are still off since the robot is not within the point zone output range.
- (5) Outputs the corresponding point number through PO200 to PO203 since the current robot position is within the zone output range (P902 to P903) and also within the point output range ($P_n \pm \text{OUT}$ valid position range). At this point, ZONE 1 output signal turns on. (ZONE 0 output signal turns off since the robot is not within the zone output range of P900 to P901).

MEMO

-
- When using an option unit, the corresponding point number for the point zone output function is output to both the corresponding parallel I/O (PO0 to PO5) and the serial I/O (PO200 to PO205). In the SRCP/SRCD series, however, the point number is only output to the serial I/O.
 - In controllers of the following versions, the position judgment parameter for selecting the point judgment method can be set to either "OUT valid position" or "Positioning-completed pulse" (this is specified in the "thousands" place of the I/O assignment selection parameter). In controllers prior to the following versions, the point zone judgment method (specified by the position judgment parameter) can only be set to "OUT valid position".

ERCX, SRCX	: Ver. 13.64 or later	DRCX	: Ver. 18.64 or later
SRCP, SRCD	: Ver. 24.21 or later	SRCP30	: Ver. 24.30H or later
 - The "OUT valid position" can be changed by parameter setting (single-axis controllers: PRM20, dual-axis controllers: PRM56 for X-axis, PRM96 for Y-axis).
 - The "Positioning-completed pulse" can be changed parameter setting (single-axis controllers: PRM6, dual-axis controllers: PRM53 for X-axis, PRM93 for Y-axis).

 CAUTION

- When the current robot position is within two or more point zone output ranges, the smaller or smallest point number is output.

Example : If the current robot position is within two point output ranges specified by P2 and P5, then P2 is output.
- If the current robot position is not within any point output range, all of PO200 to PO205 turn off.
- A 10ms sampling time is needed for position monitoring, so the point zone output might not be detected when moving the robot at high speeds.
- For point zone output and zone output, PO and ZONE0 to ZONE3 are output only when the all axes of the robot are within the output range specified for each zone.
- If outputting point 0 (P0) as the corresponding point for the point zone output function, all of PO200 to PO205 remain off (because $P0 = 000000_{(\text{binary})}$). This means that the PO200 to PO205 status does not change even after the robot has entered the zone specified by P0. This should be kept in mind when monitoring P0.

(4) Outputting the corresponding point number by the movement point zone output function

Zone outputs (ZONE 0) are also explained here.

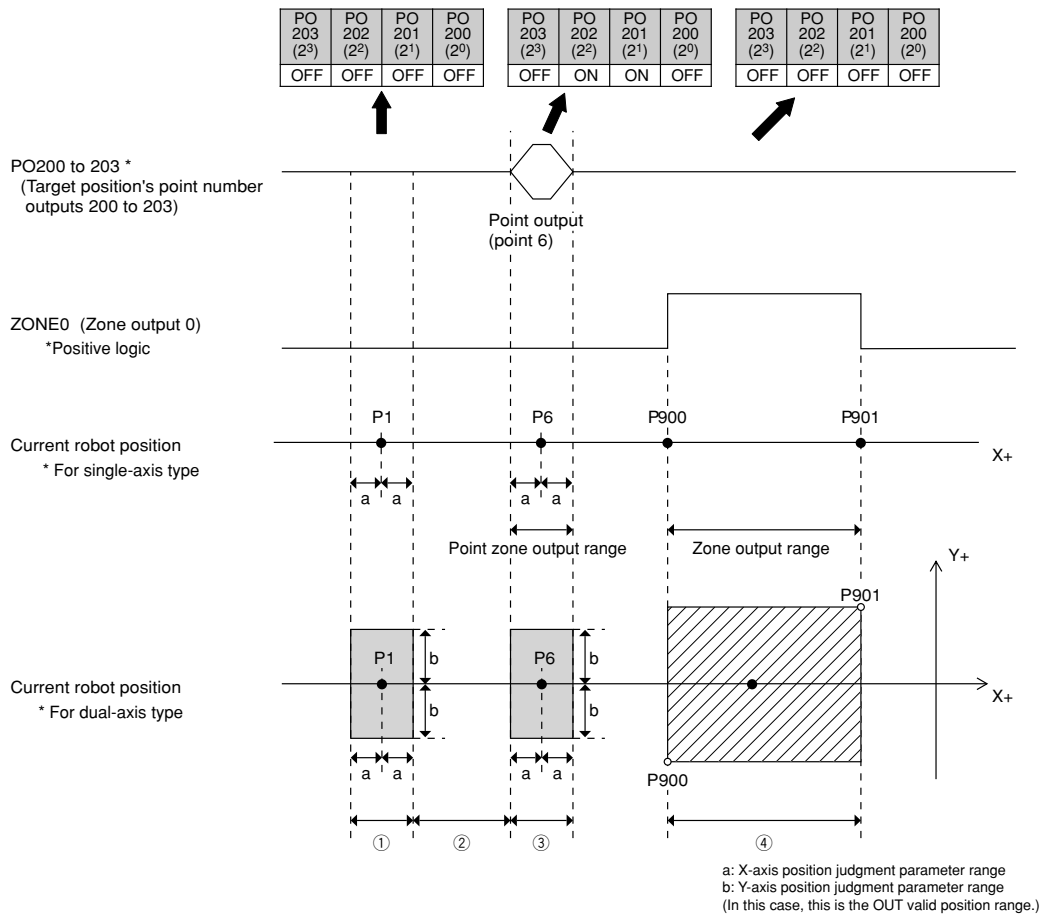

Precondition: 1) The following steps are explained assuming that the I/O assignment selection parameter (single-axis controllers: PRM59, dual-axis controllers: PRM26) is set to 321.

When I/O assignment selection parameter = 321 (single-axis controllers: PRM59, dual-axis controllers: PRM26)	
I/O assignment type	Type 2 (Point No. output type)
Permissible number of movement points	16 points
Point output selection	Movement point zone output
Point zone judgment method (position judgment parameter)	OUT valid position

- 2) The Zone 0 output is enabled and set to positive logic output by the Zone output selection parameter (single-axis controllers: PRM53, dual-axis controllers: PRM24).
- 3) Set the movement point as P6.

- (1) Although the robot is within the P1 ± OUT valid position range (point zone output range), all the PO200 to PO203 target position point number outputs are off because P1 is not the movement point. Moreover, the ZONE 0 output is also off because the robot is not within the specified zone output range.
- (2) All the PO200 to PO203 target position point number outputs are off because the robot is not within the point zone output range. Moreover, the ZONE 0 output is also off because the robot is not within the specified zone output range.

- (3) The corresponding point number P6 is output to PO200 through PO203 (P201, P202 are on; P200, P203 are off) because the robot is within the $P6 \pm \text{OUT}$ valid position range (point zone output range), and because P6 is the movement point. ZONE 0 remains off at this time because the robot is not within the specified zone output range.
- (4) The ZONE 0 output turns on because the robot is within the specified zone output range (P900 to P901). All the PO200 to PO203 target position point number outputs are off at this time because the robot is not within any point zone output range.

MEMO

- The movement point zone output function is supported by the following controller versions.

ERCX, SRCX	: Ver. 13.64 or later	DRCX	: Ver. 18.64 or later
SRCP, SRCD	: Ver. 24.21 or later	SRCP30	: Ver. 24.30H or later
- When using an option unit, the corresponding point number for the movement point zone output function is output to both the corresponding parallel I/O (PO0 to PO5) and the serial I/O (PO200 to PO205). In the SRCP/SRCD series, however, the point number is only output to the serial I/O.
- The movement point number specified just prior to movement START by point movement command (ABS-PT, INC-PT) is registered as the movement point.
- Because movement points are reset immediately after a controller power on, all PO outputs turn off. Movement points are also reset when the RESET command is executed, and movement point zone outputs by PO are cleared.
- The position judgment parameter for selecting the point zone judgment method can be set to either "OUT valid position" or "Positioning-completed pulse" (this is specified in the "thousands" place of the I/O assignment selection parameter).
- The "OUT valid position" can be changed by parameter setting (single-axis controllers: PRM20, dual-axis controllers: PRM56 for X-axis, PRM96 for Y-axis).
- The "Positioning-completed pulse" can be changed parameter setting (single-axis controllers: PRM6, dual-axis controllers: PRM53 for X-axis, PRM93 for Y-axis).

CAUTION

- All the PO200 to PO205 outputs are off when the robot is not within the point zone output range.
 - A 10ms sampling time is needed for position monitoring, so the point zone output may not be detected during high-speed robot motion.
 - For movement point zone output and zone output, PO and ZONE0 to ZONE3 are output only when the all axes of the robot are within the output range specified for each zone.
 - When outputting point 0 (P0) as the corresponding point for the movement point zone output function, all the PO200 to PO205 outputs remain off (because $P0 = 000000_{(\text{binary})}$). Therefore, the PO200 to PO205 statuses do not change even after the robot has entered the zone specified by P0. This should be kept in mind when monitoring P0.
-

2-10 Robot language

The robot language expanded by using in the PROFIBUS unit.

2-10-1 MOVF

Function: Moves until the specified DI or SI No. is input.

Format: MOVF <point no.> <DI or SI No.> <input status>

Example: MOVF 1,2,1

This command moves the robot towards P1, ends movement when D12 turns ON, and proceeds to the next step.

Explanation: MOVF is used when searching for the target position with sensors, etc. The robot starts movement when all axes enter the positioning-complete pulse range, and stops when the SI and DI conditions are met. Even if the SI or DI conditions are not met, the command ends at the stage the robot reaches the specified point, and proceeds to the next step.

(1) Point numbers

Point numbers are identifying numbers assigned to 1,000 points in a range from 0 to 999. These point numbers are used to create point data in point mode. As a special usage method, when a character called 'P' is input here, a point variable defined by the P character is set in the point No.

(2) DI or SI numbers

Specify one from among serial general-purpose inputs 200 - 231 (32 points) or general-purpose inputs 0 - 15 (16 points)*.

(3) Input status

Here, "1" means ON, and "0" means OFF.

Other: • The speed during execution of the MOVF statement can be set with the MOVF speed parameter. This has no effect on speed in OPRT mode.

* 0 to 7 (8 points) for the SRCP/SRCD series controllers

2-10-2 JMPF

Function: Jumps to the specified label of the specified program when the jump condition input matches the value that was set.

Format: JMPF <label No.> <program No.> <input condition value>

Example: JMPF 12,3,5

Jumps to label 12 of program 3 when the condition jump input value is 5. If not, proceeds to the next step.

Explanation: JMPF is a command to control the program flow according to the condition jump input.

(1) Label No.

The label No. is a number defined by the character L, and signifies the jump destination. This number can be specified from 0 to 255.

(2) Program No.

The program numbers are numbers assigned to 100 programs ranging from 0 to 99.

(3) Input condition value

This value sets the condition for the jump. A general-purpose input or a serial general-purpose input is considered a binary input value, and the jump is performed if it matches the input value conditions. The number of points that can be sub-grouped by input condition depends on the number of conditional input points. The number of conditional input points is set by the conditional input point parameter (single-axis controllers: PRM8, dual-axis controllers: PRM0).

Others: • The conditional input point parameters have been expanded as follows.

Input range: 1 - 8, 11 - 18

Initial value: 4

Conditional input points - general-purpose input and condition range

Conditional input points	General-purpose inputs used	Settable conditional input range
1	DI0	0-1
2	DI0-DI1	0-3
3	DI0-DI2	0-7
4	DI0-DI3	0-15
5	DI0-DI4	0-31
6	DI0-DI5	0-63
7	DI0-DI6	0-127
8	DI0-DI7	0-255
11	SI200	0-1
12	SI200-SI201	0-3
13	SI200-SI202	0-7
14	SI200-SI203	0-15
15	SI200-SI204	0-31
16	SI200-SI205	0-63
17	SI200-SI206	0-127
18	SI200-SI207	0-255

2-10-3 JMPB

Function: Jumps to the specified label when the specified general-purpose input or memory input or serial general-purpose input is on (or off).

Format: JMPB <label No.> <DI or MI or SI No.> <input status>

Example: JMPB 12,8,1

Jumps to level 12 when D18 is ON. If not, proceeds to the next step.

Explanation: JMPB is a command to control the program flow according to the general-purpose input or memory input or serial general-purpose input.

(1) Label No.

The label No. is a number defined by the character L, and signifies the jump destination. This number can be specified from 0 to 255.

(2) DI or MI or SI No.

Specify 1 number from among the general-purpose inputs 0 - 15 (16 points)* or memory input 100 -147 (48 points) or the serial general-purpose inputs 200- 231 (32 points).

(3) Input status

Here, "1" means ON, and "0" means OFF.

* 0 to 7 (8 points) for the SRCP/SRCD series controllers

2-10-4 DO

Function: Turns the general-purpose output or memory output or serial general-purpose output on or off.

Format: DO <DO or MO or SO No.> <Output status>

Example: DO 3,1

Sets DO3 to ON.

Explanation: The DO command turns the general-purpose output or memory output or serial general-purpose output ON or OFF.

(1) DO or MO or SO No.

Specify one from among the general-purpose outputs 0 - 12 (13 points)* or memory output 100 -131 (32 points) or the serial general-purpose outputs 200- 231 (32 points).

(2) Output status

Here, "1" means ON, and "0" means OFF.

* 0 to 4 (5 points) for the SRCP/SRCD series controllers

2-10-5 WAIT

Function: Waits until the specified general-purpose input or memory input or serial general-purpose input sets to the specified status.

Format: WAIT <DI or MI or SI No.> <Input status>

Example: WAIT 5,1

Waits until DI5 sets to ON.

Explanation: The WAIT command adjusts the timing according to the status of the general-purpose input or memory input or serial general-purpose input.

(1) DI or MI or SI numbers

Specifies one from among the general-purpose inputs 0 - 15 (16 points)* or memory input 100 -147 (48 points) or the serial general-purpose outputs 200- 231 (32 points).

(2) Input status

Here, “1” means the input is ON, and “0” means the input is OFF.

* 0 to 7 (8 points) for the SRCP/SRCD series controllers

2-11 Emulated Serialization on parallel DIO

This is a function to directly send the input from the master sequencer (PLC) to the external parallel I/O, or to directly send an external parallel I/O input to a master sequencer (PLC). An I/O port set for this function, can be controlled by the master sequencer (PLC), independently of the robot program so outputs can be handled as if from a separate slave station.

This function is selected on the HPB, and can be set for any I/O. The SI200 - SI212*¹ inputs match the DO0 - DO12*² outputs, and the DI0 - DI15*³ inputs match the SO200 - SO215*⁴ outputs. (Emulated serialization cannot be performed on SI213 - SI231*⁵.)

Normal

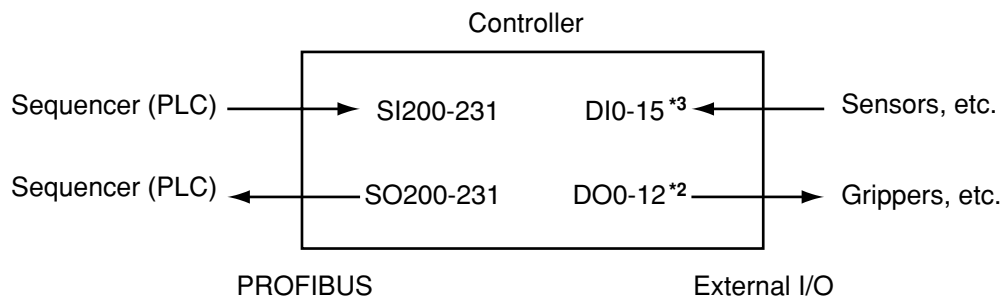

Emulated serialization

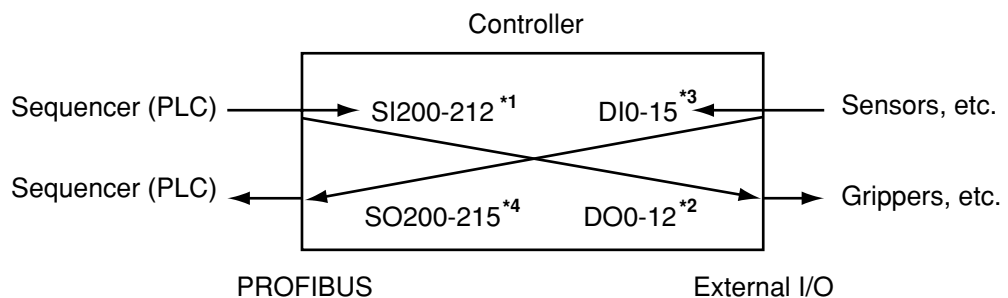

More specifically, when emulated serialization is only for DI1, the DI1 status is output to SO201. Output of SO201 with the DO statement is disabled at this time. DI0, DI2 - DI15 and SO200, SO202 - SO215 can be used as normal input/outputs.

- * The DO statement is invalid on output ports that used emulated serialization on a parallel I/O.
- * Do not make simultaneous function settings with parameters such as for emulated serialization parallel I/O settings, origin return end action selection and servo status output selection, and alarm number output selection since the functions will not operate normally.

- *1: SI200 to SI204 when the SRCP/SRCD series controllers are used.
- *2: DO0 to DO4 when the SRCP/SRCD series controllers are used.
- *3: DI0 to DI7 when the SRCP/SRCD series controllers are used.
- *4: SO200 to SO207 when the SRCP/SRCD series controllers are used.
- *5: SI205 to SI231 when the SRCP/SRCD series controllers are used.

- 1) Press **F3** (SYS) on the initial screen.

```
[MENU]
select menu

1EDIT2OPRT3SYS 4MON
```

- 2) Press **F4** (next) to switch to the function display. When the function display appears, then press **F2** (OPT).

```
[SYS]
select menu

1SAFE2OPT 3UTL 4next
```

- 3) Press **F4** (next) to switch the function display. To directly send the external parallel I/O input to the master sequencer (PLC) press **F1** (D→SO). To directly send the input from the master sequencer (PLC) to the external parallel I/O, press **F2** (S→DO).

```
[SYS-OPT]
select menu

1D-SO2S→DO3 4next
```

- 4) This is the screen when **F1** (D→SO) was selected above in step 3). The DI15 - DI0 current settings appear on the screen from the left side. Here, “0” indicates normal status, and “1” indicates a emulated serialization setting.

```
[SYS-OPT-D→SO]
DI 00001111 00000000
DI→SO connect
1DI0 2DI1 3DI2 4next
```

To change a setting, press the function key displaying the DI No. you want to set. If the DI No. you want to set is not shown, just press the **F4** (next) as many times as needed to select DI3 - DI15.

- 5) This is the screen when **F2** (S→DO) was selected above in step 3). The DO12 - DO0 current settings appear on the screen from the left side. Here, “0” indicates normal status, and “1” indicates a emulated serialization setting.

```
[SYS-OPT-S→DO]
DO 00011 00000000
SI→DO connect
1DO0 2DO1 3DO2 4next
```

To change a setting, press the function key displaying the DI No. you want to set. If the DI No. you want to set is not shown, just press the **F4** (next) as many times as needed to select DO3 - DO12.

- 6) Press the **ESC** key to return to the screen in step 3).

```
[SYS-OPT]
select menu

1D-SO2S→DO3 4next
```

2-12 Remote command

When the remote register is used, the message command can be issued directly from the sequencer (PLC). The high-ranked commands such as MOVD command (movement command which directly specifies the position coordinates), which must use RS-232C unit conventionally, can be easily executed. The method to use these commands is explained in this section.

2-12-1 Remote command specifications

The following functions are assigned to the remote register.

OUTPUT (Remote→Master)		INPUT (Master→Remote)	
Address	Description	Address	Description
IWm+8	Status	QWn+8	Execution command
IWm+10	Reserved	QWn+10	
IWm+12	Command response	QWn+12	Command option
IWm+14		QWn+14	
IWm+16		QWn+16	
IWm+18		QWn+18	
IWm+20		QWn+20	
IWm+22		QWn+22	

- The remote command is executed by setting QWn+8 and QWn+10 with the command code desired to execute. When the controller receives the command, it will execute the process, and inform the result (status) to the master sequencer (PLC) side via IWm+8. When the command is ended, set QWn+8 to 0, and clear the status. After the status is cleared, the next command can be executed.
- The command is sometimes provided with options on the remote command. The option data is set at QWn+12 to QWn+22. Since the number of options, size and setting address of the command option are different in each command, refer to "2-12-3 Remote command details (robot operation)" and the subsequent sections. Similarly, some commands return the data to the master sequencer (PLC) side as the response. In this case, the response data is set at IWm+12 to Wm+22. Like the command option, the number of options, size and setting address of the response data are also different in each command.

* Even if the data is set at the register not defined as any command option when the command is executed, there is not any problem. (It is unnecessary to clear the not-defined register to 0.). Moreover, the register which is not defined as the response data is not influenced during the command execution, and the register content before the command execution is held.
- It is necessary to set the command option to the register at the same time when or before the command desired to execute is set.
- The data is set with the binary code. If the data size exceeds 16 bits (1 word), set the data of the upper-ranked bit at the higher address. (Little endian)
 Example: To set 12345678 (hexadecimal) at the register of QWn+12 and QWn+14, set 1234 (hexadecimal) at QWn+14 and 5678 (hexadecimal) at QWn+12.
- IWm+10 is the system reservation. When it is read, 0 is returned.

2-12-2 Remote command & status value list

The remote command code and status code are expressed in the hexadecimal mode.

Remote Command

Remote Command (QWn+10,QWn+8)	Meaning of command
0000xxxx	The command of the code xxxx is executed.
0001xxxx	The command of the code xxxx is executed with the current position information indicated at IWm+16 to IWm+22.

Status

Status value (IWm+8)	Meaning of status
0000	Command ready
0100	Command executing
0200	Command normal end
40xx	Error occurrence (xx: Error code)
80xx	X axis alarm occurrence (xx: Alarm code)
81xx	Y axis alarm occurrence (xx: Alarm code)

1. Robot movement

No.	Remote Command (QWn+8)		Command option		Command response	
	Code	Command details	Option	register	response	register
1.	0101	Return-to-origin execution	Axis	QWn+12		
2.	0102	Program reset				
3.	0103	Automatic operation start				
4.	0104	Step operation start				
5.	0105	Servo status change	Axis	QWn+12		
			Status	QWn+14		
6.	0106	JOG movement (inching)	Axis	QWn+12		
			Movement direction	QWn+14		
7.	0107	JOG movement	Axis	QWn+12		
			Movement direction	QWn+14		
8.	0108	Direct position specification movement execution	Axis	QWn+12		
			Speed	QWn+14		
			X axis position	QWn+18, QWn+16		
			Y axis position	QWn+22, QWn+20		
9.	0109	Position specification movement execution	Axis	QWn+12		
			Point number	QWn+14		
			Speed	QWn+16		
10.	010A	Movement stroke specification movement execution	Axis	QWn+12		
			Point number	QWn+14		
			Speed	QWn+16		
11.	010B	General-purpose input response movement execution	Axis	QWn+12		
			Point number	QWn+14		
			DI/SI number	QWn+16		
			0 or 1	QWn+18		

No.	Remote Command (QWn+8)		Command option		Command response	
	Code	Command details	Option	register	response	register
12.	010C	Pallet work position specification movement execution	Axis	QWn+12		
			Pallet work position	QWn+14		
			Speed	QWn+16		
13.	010D	Position specification arch motion definition	Axis	QWn+12		
			Specified position	QWn+14		
14.	010E	Distance specification arch motion definition	Axis	QWn+12		
			Specified distance	QWn+14		
15.	010F	General-purpose output or memory output status change	DO/MO/SO number	QWn+12		
16.	0110	General-purpose input or memory input wait	DI/MI/SI number	QWn+12		
			0 or 1	QWn+14		
17.	0111	Specified time waiting	Time	QWn+12		
18.	0112	Matrix definition	Line number	QWn+12		
			Array number	QWn+14		
			Pallet number	QWn+16		
19.	0113	Movement matrix specification	Pallet number	QWn+12		
20.	0114	Point variable P definition	Point number	QWn+12		
21.	0115	Addition of specified value to point variable P	Addition value	QWn+12		
22.	0116	Subtraction of specified value from point variable P	Subtraction value	QWn+12		
23.	0117	Arrangement element specification of counter arrangement variable C	Arrangement element No.	QWn+12		
24.	0118	Counter arrangement variable C definition	Counter value	QWn+12		
25.	0119	Addition of specified value to counter arrangement variable C	Addition value	QWn+12		
26.	011A	Subtraction of specified value from counter arrangement variable C	Subtraction value	QWn+12		
27.	011B	Counter variable D definition	Counter value	QWn+12		
28.	011C	Addition of specified value to counter variable D	Addition value	QWn+12		
29.	011D	Subtraction of specified value from counter variable D	Subtraction value	QWn+12		
30.	011E	Shift execution of position data	Point number	QWn+12		
31.	011F	Linear interpolation movement execution	Axis	QWn+12		
			Point number	QWn+14		
			Speed	QWn+16		
32.	0120	Circular interpolation movement execution	Point number	QWn+12		
			Speed	QWn+14		
			Locus specification	QWn+16		

2. Data handling

No.	Remote Command (QWn+8)		Command option		Command response	
	Code	Command details	Option	register	response	register
1.	0201	Current position read	Axis	QWn+12	X axis position	IWm+18, IWm+16
					Y axis position	IWm+22, IWm+20
2.	0202	Current program No. read			Program number	IWm+12
3.	0203	Current step No. read			Step number	IWm+12
4.	0204	Current task No. read			Task number	IWm+12
5.	0205	Current point No. read			Point number	IWm+12
6.	0206	ROM version No. read			Version value	IWm+12
7.	0207	Axis number read			Axis number	IWm+12
8.	0208	Emergency stop status check			Emergency stop status	IWm+12
9.	0209	Servo status check	Axis	QWn+12	Servo status	IWm+12
10.	020A	Return-to-origin status check	Axis	QWn+12	Return-to-origin status	IWm+12
11.	020B	Service mode status check			Service mode status	IWm+12
12.	020C	Operation mode check			Operation mode status	IWm+12
13.	020D	Matrix definition content read	Pallet number	QWn+12	Array number	IWm+12
					Line number	IWm+14
14.	020E	Currently specified matrix No. read			Matrix No.	IWm+12
15.	020F	Current point variable P read			Point number	IWm+12
16.	0210	Arrangement element No. read of currently specified C			Arrangement element No.	IWm+12
17.	0211	Counter arrangement variable C read	Arrangement element No.	QWn+12	Counter arrangement variable	IWm+12
18.	0212	Current counter variable D read			Counter variable	IWm+12
19.	0213	Current shift data read			X axis shift data	IWm+18, IWm+16
					Y axis shift data	IWm+22, IWm+20
20.	0214	General-purpose input and memory input status read	DI/MI/SI number	QWn+12	Input status	IWm+12
21.	0215	General-purpose output and memory output status read	DO/MO/SO number	QWn+12	Output status	IWm+12
22.	0216	Specified parameter data read	Parameter number	QWn+12	Parameter value	IWm+14, IWm+12
23.	0217	Specified point data read	Point number	QWn+12	X axis data	IWm+18, IWm+16
					Y axis data	IWm+22, IWm+20

3. Utility

No.	Remote Command (QWn+8)		Command option		Command response	
	Code	Command details	Option	register	response	register
1.	0301	Execution program No. switching	Program number	QWn+12		
2.	0302	Execution task No. switching	Task number	QWn+12		
3.	0303	Parameter data write	Parameter number	QWn+12		
			Parameter data	QWn+18, QWn+16		
4.	0304	Point data write	Point number	QWn+12		
			Axis	QWn+14		
			X axis data	QWn+18, QWn+16		
			Y axis data	QWn+22, QWn+20		

4. Special commands

No.	Remote Command (QWn+8)		Command option		Command response	
	Code	Command details	Option	register	response	register
1.	0000	No execution (status clear)				
2.	0401	Response register initialization	Initial value data	QWn+22, QWn+20, QWn+18, QWn+16, QWn+14, QWn+12	Initial status	IWm+22, IWm+20, IWm+18, IWm+16, IWm+14, IWm+12

2-12-3 Remote command details (robot operation)

(1) Return-to-origin execution Code 0101

The return-to-origin operation of all axes or specified axis is executed, or the return-to-origin status is judged. If the search system is selected for the origin-point detection system, the return-to-origin operation is executed, and if the mark system is selected, the return-to-origin status is judged.

Command option					
QWn+22	QWn+20	QWn+18	QWn+16	QWn+14	QWn+12
					Axis

Command response					
IWm+22	IWm+20	IWm+18	IWm+16	IWm+14	IWm+12

(Details)

Axis: 0 means all axes, 1 means X axis, and 2 means Y axis. On dual-axis controllers, all axes are also specified when 3 is set. On single-axis controllers, 0 and 1 alone can be specified.

(Example)

Transmission example 1:

Return-to-origin is executed to all axes.

QWn+22	QWn+20	QWn+18	QWn+16	QWn+14	QWn+12	QWn+10	QWn+8
0000	0000	0000	0000	0000	0000	0000	0101

Response example 1:

It is normally ended.

IWm+22	IWm+20	IWm+18	IWm+16	IWm+14	IWm+12	IWm+10	IWm+8
0000	0000	0000	0000	0000	0000	0000	0200

Response example 2:

Origin incomplete occurs since the return-to-origin is not completed in the axis of the mark system.

IWm+22	IWm+20	IWm+18	IWm+16	IWm+14	IWm+12	IWm+10	IWm+8
0000	0000	0000	0000	0000	0000	0000	4020

MEMO

 If any axis of the mark system and axis of the search system are mixed, it is necessary to previously complete the return-to-origin of the axis of the mark system in order to execute the return-to-origin of the axis of the search system. The return-to-origin of the mark system is executed with HPB.

MEMO

 If the return-to-origin is once executed after the robot cable is connected to the absolute battery, it is unnecessary to execute it again even if the power supply is turned off. (As an exceptional example, it is necessary to execute the return-to-origin again since the origin is incomplete if the absolute back-up function is made to be invalid or if any parameter concerned with the origin is changed.)

⚠ CAUTION

In return-to-origin of the stroke end origin system, do not stop return-to-origin operation during origin detection (mechanical limit in contact). The alarm stop results from the overload of the controller, and it is necessary to turn ON the power supply again.

⚠ CAUTION

If return-to-origin of the stroke end origin system is inevitably repeated, provide an interval of 5 seconds or more between the repeated operations.

- (2) **Program reset** **Code 0102**
 Return the step of the program to the 1st step of the head program, and turn OFF all DO0 to DO12*1, SO200 to SO231 and memory I/O. Moreover, also clear the point variable "P" to 0. (Do not clear the counter variables "C" and "D".)

Command option					
QWn+22	QWn+20	QWn+18	QWn+16	QWn+14	QWn+12

Command response					
IWm+22	IWm+20	IWm+18	IWm+16	IWm+14	IWm+12

(Example)
 Transmission example 1:

Execute the program reset.

QWn+22	QWn+20	QWn+18	QWn+16	QWn+14	QWn+12	QWn+10	QWn+8
0000	0000	0000	0000	0000	0000	0000	0102

Response example 1:
 It is normally ended.

IWm+22	IWm+20	IWm+18	IWm+16	IWm+14	IWm+12	IWm+10	IWm+8
0000	0000	0000	0000	0000	0000	0000	0200

CAUTION

At the output port which has simulatively serialized the parallel I/O, any output does not vary even if the reset command is executed.

CAUTION

If the return-to-origin completing operation selection parameter (single-axis controllers:PRM33, dual-axis controllers:PRM2) is set to 1 or 3, DO4*2 will not be turned OFF even if the reset command is executed. If the servo status output selection parameter (single-axis controllers:PRM46, dual-axis controllers:PRM21) is set to 1, DO7*3 will similarly not be turned OFF even if the reset command is executed.

MEMO

The head program is the program selected by switching the program which is finally executed at HPB or POPCOM.
 The head program is also switched when the communication command "@SWI" is executed. Moreover, when the program data is loaded from the memory card to the controller, it is sometimes switched.

*1: DO0 to DO4 when the SRCP/SRCD series controllers are used.
 *2: DO5 when the DRCX series controllers are used.
 *3: DO3 when the SRCP/SRCD series controllers are used.

(3) Automatic operation start..... Code 0103

The program is executed to the final step.

In the multi task program, all tasks are executed.

Command option					
QWn+22	QWn+20	QWn+18	QWn+16	QWn+14	QWn+12

Command response					
IWm+22	IWm+20	IWm+18	IWm+16	IWm+14	IWm+12

(Example)

Transmission example 1:

Automatic operation is started.

QWn+22	QWn+20	QWn+18	QWn+16	QWn+14	QWn+12	QWn+10	QWn+8
0000	0000	0000	0000	0000	0000	0000	0103

Response example 1:

It is executed to the final step.

IWm+22	IWm+20	IWm+18	IWm+16	IWm+14	IWm+12	IWm+10	IWm+8
0000	0000	0000	0000	0000	0000	0000	0200

Response example 2:

The origin incomplete error occurs to interrupt the robot operation.

IWm+22	IWm+20	IWm+18	IWm+16	IWm+14	IWm+12	IWm+10	IWm+8
0000	0000	0000	0000	0000	0000	0000	4020

CAUTION

If any endless program (in which it unconditionally return to the program head from the final step) is executed, the response will stay at 0100 (command executing) since the program is not ended. In this case, the program is stopped by inputting the stop command of the interlock, etc. or activating the emergency stop to forcibly stop.

(4) Step operation start Code 0104

The program is executed by one step.

In the multi task program, the task selected at the time is executed.

Command option					
QWn+22	QWn+20	QWn+18	QWn+16	QWn+14	QWn+12

Command response					
IWm+22	IWm+20	IWm+18	IWm+16	IWm+14	IWm+12

(Example)

Transmission example 1:

The step operation is started.

QWn+22	QWn+20	QWn+18	QWn+16	QWn+14	QWn+12	QWn+10	QWn+8
0000	0000	0000	0000	0000	0000	0000	0104

Response example 1:

The step operation is completely executed.

IWm+22	IWm+20	IWm+18	IWm+16	IWm+14	IWm+12	IWm+10	IWm+8
0000	0000	0000	0000	0000	0000	0000	0200

Response example 2:

The origin incomplete error occurs to interrupt the robot operation.

IWm+22	IWm+20	IWm+18	IWm+16	IWm+14	IWm+12	IWm+10	IWm+8
0000	0000	0000	0000	0000	0000	0000	4020

(5) Servo status change Code 0105

The servo of all axes or specified axis is turned ON and OFF.

Command option					
QWn+22	QWn+20	QWn+18	QWn+16	QWn+14	QWn+12
				Status	Axis

Command response					
IWm+22	IWm+20	IWm+18	IWm+16	IWm+14	IWm+12

(Details)

Axis: 0 means all axes, 1 means X axis and 2 means Y axis. On dual-axis controllers, all axes are also specified when 3 is set.

On single-axis controllers, 0 or 1 alone can be specified.

Status: 1 means servo-ON, and 0 means servo-OFF.

(Example)

Transmission example 1:

Servo-OFF is set for all axes.

QWn+22	QWn+20	QWn+18	QWn+16	QWn+14	QWn+12	QWn+10	QWn+8
0000	0000	0000	0000	0000	0000	0000	0105

Response example 1:

It is normally ended.

IWm+22	IWm+20	IWm+18	IWm+16	IWm+14	IWm+12	IWm+10	IWm+8
0000	0000	0000	0000	0000	0000	0000	0200

(6) JOG movement (inching)..... Code 0106

The specified axis moves in the specified direction at the stroke shown with the following formula.

$$\text{Movement stroke} = 1 \times (\text{Teach movement data } (\%) * 100 \text{ (mm)})$$

Command option					
QWn+22	QWn+20	QWn+18	QWn+16	QWn+14	QWn+12
				Direction	Axis

Command response					
IWm+22	IWm+20	IWm+18	IWm+16	IWm+14	IWm+12

(Details)

- Axis: 1 means X axis, and 2 means Y axis.
 On single-axis controllers, 1 alone can be specified.
- Direction: 0 means + direction, and 1 means - direction.

(Example)

Transmission example 1:

Y axis is moved only at the specified stroke in the - direction.

QWn+22	QWn+20	QWn+18	QWn+16	QWn+14	QWn+12	QWn+10	QWn+8
0000	0000	0000	0000	0001	0001	0000	0106

Response example 1:

It is normally ended.

IWm+22	IWm+20	IWm+18	IWm+16	IWm+14	IWm+12	IWm+10	IWm+8
0000	0000	0000	0000	0000	0000	0000	0200



If the robot is the rotary axis, the unit is degree.

* Single-axis controllers: PRM26, dual-axis controllers: PRM12

(7) JOG movement Code 0107

The specified axis continues moving in the specified direction at the movement speed shown with the following formula until the interlock input is OFF or it reaches the software limit.

$$\text{Movement speed} = 100 \times (\text{Teach movement data (\%)} / 100 \text{ (mm)})$$

Command option					
QWn+22	QWn+20	QWn+18	QWn+16	QWn+14	QWn+12
				Direction	Axis

Command response					
IWm+22	IWm+20	IWm+18	IWm+16	IWm+14	IWm+12

(Details)

Axis: 1 means X axis, and 2 means Y axis.
 On single-axis controllers, 1 alone can be specified.
 Direction: 0 means + direction, and 1 means - direction.

(Example)

Transmission example 1:

Y axis is moved only at the specified speed in the - direction.

QWn+22	QWn+20	QWn+18	QWn+16	QWn+14	QWn+12	QWn+10	QWn+8
0000	0000	0000	0000	0001	0001	0000	0107

Response example 1:

It reaches the software limit, and is normally ended.

IWm+22	IWm+20	IWm+18	IWm+16	IWm+14	IWm+12	IWm+10	IWm+8
0000	0000	0000	0000	0000	0000	0000	0200

CAUTION

If the robot is the rotary axis, the unit is degree.

CAUTION

In the JOG movement, it is also regarded as the normal end that the movement is stopped after the interlock input is OFF.

CAUTION

Take care that the software limit is invalid in the origin incomplete state.

* Single-axis controllers: PRM26, dual-axis controllers: PRM12

(8) Direct position specification movement execution Code 0108

It moves to the specified coordinate position.

Command option					
QWn+22	QWn+20	QWn+18	QWn+16	QWn+14	QWn+12
Y axis position		X axis position		Speed	Axis

Command response					
IWm+22	IWm+20	IWm+18	IWm+16	IWm+14	IWm+12

(Details)

Axis: 0 means all axes, 1 means X axis and 2 means Y axis. On dual-axis controllers, all axes are also specified when 3 is set.

On single-axis controllers, 0 or 1 alone can be specified.

Speed: It can be set at 100 intervals from 1 to 100, and 100=3000rpm if the program execution speed parameter*1 is set to 100. (In this case, the maximum speed setting parameter*2 is set to 3000.)

Axis position: The desired movement position is directly specified (unit: 0.01mm). When the robot is set at the rotary axis, the unit of the movement position is 0.01 degrees. When the axis is specified, the axis data is free for any other axis not specified. Similarly, it does not matter that the data of Y axis is free on single-axis controllers.

(Example)

Transmission example 1:

In the current position indication mode, it moves to the position of X=50.37 and Y=45.55 at the 100% speed.

QWn+22	QWn+20	QWn+18	QWn+16	QWn+14	QWn+12	QWn+10	QWn+8
0000	11CB	0000	13AD	0064	0000	0001	0108

Response example 1:

It is normally ended.

IWm+22	IWm+20	IWm+18	IWm+16	IWm+14	IWm+12	IWm+10	IWm+8
0000	11CB	0000	13AD	0000	0000	0000	0200

Transmission example 2:

It moves to the position of Y=850.00 at the 50% speed.

QWn+22	QWn+20	QWn+18	QWn+16	QWn+14	QWn+12	QWn+10	QWn+8
0001	4C08	0000	0000	0032	0002	0000	0108

Response example 2:

The software limit over occurs.

IWm+22	IWm+20	IWm+18	IWm+16	IWm+14	IWm+12	IWm+10	IWm+8
0000	0000	0000	0000	0000	0000	0000	401E

*1: Single-axis controllers: PRM30, dual-axis controllers: PRM17

*2: Single-axis controllers: PRM44, dual-axis controllers: PRM64 and PRM104

- (9) **Position specification movement execution Code 0109**
 The specified axis moves the position of the data of the point No. specified with the number.

Command option					
QWn+22	QWn+20	QWn+18	QWn+16	QWn+14	QWn+12
			Speed	Point number	Axis

Command response					
IWm+22	IWm+20	IWm+18	IWm+16	IWm+14	IWm+12

(Details)

Axis: 0 means all axes, 1 means X axis and 2 means Y axis. On dual-axis controllers, all axes are also specified when 3 is set.

On single-axis controllers, 0 or 1 alone can be specified.

Point number: This is the inherent number assigned to each of 1000 points as a total from 0 to 999. To specify the point variable P, register 4095 (=0FFF (hexadecimal)).

Speed: It can be set at 100 intervals from 1 to 100, and 100=3000rpm if the program execution speed parameter*1 is set to 100. (In this case, the maximum speed setting parameter*2 is set to 3000.)

(Example)

Transmission example 1:

It moves to the position of P123 at the speed 100%.

QWn+22	QWn+20	QWn+18	QWn+16	QWn+14	QWn+12	QWn+10	QWn+8
0000	0000	0000	0064	007B	0000	0000	0109

Response example 1:

It is normally ended.

IWm+22	IWm+20	IWm+18	IWm+16	IWm+14	IWm+12	IWm+10	IWm+8
0000	0000	0000	0000	0000	0000	0000	0200

Response example 2:

The software limit over occurs.

IWm+22	IWm+20	IWm+18	IWm+16	IWm+14	IWm+12	IWm+10	IWm+8
0000	0000	0000	0000	0000	0000	0000	401E

*1: Single-axis controllers: PRM30, dual-axis controllers: PRM17

*2: Single-axis controllers: PRM44, dual-axis controllers: PRM64 and PRM104

(10) Movement stroke specification

movement execution Code 010A

The specified axis moves from the current position by the data of the point number specified.

Command option					
QWn+22	QWn+20	QWn+18	QWn+16	QWn+14	QWn+12
			Speed	Point number	Axis

Command response					
IWm+22	IWm+20	IWm+18	IWm+16	IWm+14	IWm+12

(Details)

Axis: 0 means all axes, 1 means X axis and 2 means Y axis. On dual-axis controllers, all axes are also specified when 3 is set.

On single-axis controllers, 0 or 1 alone can be specified.

Point number: This is the inherent number assigned to each of 1000 points as a total from 0 to 999. To specify the point variable P, register 4095 (=0FFF (hexadecimal)).

Speed: It can be set at 100 intervals from 1 to 100, and 100=3000rpm if the program execution speed parameter*1 is set to 100. (In this case, the maximum speed setting parameter*2 is set to 3000.)

(Example)

Transmission example 1:

It moves from the current position by the P123 stroke alone at the speed 100%.

QWn+22	QWn+20	QWn+18	QWn+16	QWn+14	QWn+12	QWn+10	QWn+8
0000	0000	0000	0064	007B	0000	0000	010A

Response example 1:

It is normally ended.

IWm+22	IWm+20	IWm+18	IWm+16	IWm+14	IWm+12	IWm+10	IWm+8
0000	0000	0000	0000	0000	0000	0000	0200

Response example 2:

The software limit over occurs.

IWm+22	IWm+20	IWm+18	IWm+16	IWm+14	IWm+12	IWm+10	IWm+8
0000	0000	0000	0000	0000	0000	0000	401E

CAUTION

Since the current position on the program does not vary if the movement is interrupted due to the stop (interlock), etc., the movement can be continued by executing the command again. However, if resetting is executed, the current position on the program will be initialized at the position of the robot.

*1: Single-axis controllers: PRM30, dual-axis controllers: PRM17

*2: Single-axis controllers: PRM44, dual-axis controllers: PRM64 and PRM104

(11) General-purpose input response movement execution Code 010B

Until the conditions of DI/SI input are established, the specified axis continues moving to the specified point position. When the DI/SI conditions are established, the robot stops and the command is normally ended. Even if any DI/SI condition is not established, the command is normally ended at the step where it reaches the target point.

Command option					
QWn+22	QWn+20	QWn+18	QWn+16	QWn+14	QWn+12
		DI/SI status	DI/SI number	Point number	Axis

Command response					
IWm+22	IWm+20	IWm+18	IWm+16	IWm+14	IWm+12

(Details)

- Axis: 0 means all axes, 1 means X axis and 2 means Y axis. On dual-axis controllers, all axes are also specified when 3 is set. On single-axis controllers, 0 or 1 alone can be specified.
- Point number: This is the inherent number assigned to each of 1000 points as a total from 0 to 999. To specify the point variable P, register 4095 (=0FFF (hexadecimal)).
- DI/SI number: Specify one among the general-purpose input DI0 to 15*1 and SI200 to 231.
- DI/SI status: 1 means ON, and 0 means OFF.

(Example)

Transmission example 1:

Y axis alone is continuously moved to the position of P2 until SI210=1 (ON).

QWn+22	QWn+20	QWn+18	QWn+16	QWn+14	QWn+12	QWn+10	QWn+8
0000	0000	0001	00D2	0002	0001	0000	010B

Response example 1:

Since the conditions are established on the way of movement, the robot stops with the normal end.

IWm+22	IWm+20	IWm+18	IWm+16	IWm+14	IWm+12	IWm+10	IWm+8
0000	0000	0000	0000	0000	0000	0000	0200



The movement speed is set with MOVF speed parameter*2 but is not influenced by the program execution speed parameter*3.

*1: DI0 to DI7 when the SRCP/SRCD series controllers are used.
 *2: Single-axis controllers: PRM9, dual-axis controllers: PRM4
 *3: Single-axis controllers: PRM30, dual-axis controllers: PRM17

(12) Pallet work position specification movement execution Code 010C

It moves to the pallet work position specified with the matrix.

Command option					
QWn+22	QWn+20	QWn+18	QWn+16	QWn+14	QWn+12
			Speed	Pallet work position	Axis

Command response					
IWm+22	IWm+20	IWm+18	IWm+16	IWm+14	IWm+12

(Details)

Axis: 0 means all axes, 1 means X axis and 2 means Y axis. On dual-axis controllers, all axes are also specified when 3 is set.

On single-axis controllers, 0 or 1 alone can be specified.

Pallet work position:

It is the inherent number which is given to each square of the matrix, being a value in the range of 1 to max. 65025 (= 255×255). In addition, the counter arrangement variable "C" or "D" can also be used. 65535 (=FFFF (hexadecimal)) is registered for C, and 65534 (=FFFE (hexadecimal)) is registered for D.

Speed: It can be set at 100 intervals from 1 to 100, and 100=3000rpm if the program execution speed parameter*1 is set to 100. (In this case, the maximum speed setting parameter*2 is set to 3000.)

(Example)

Transmission example 1:

If the matrix of 4×3 is defined, it moves to the 2nd line and 2nd array at the speed 100%.

QWn+22	QWn+20	QWn+18	QWn+16	QWn+14	QWn+12	QWn+10	QWn+8
0000	0000	0000	0064	0005	0000	0000	010C

Response example 1:

It is normally ended.

IWm+22	IWm+20	IWm+18	IWm+16	IWm+14	IWm+12	IWm+10	IWm+8
0000	0000	0000	0000	0000	0000	0000	0200

Transmission example 2:

If the matrix of 5×5 is defined, Y axis alone moves at the speed 50% to the pallet work position specified with the counter variable D.

QWn+22	QWn+20	QWn+18	QWn+16	QWn+14	QWn+12	QWn+10	QWn+8
0000	0000	0000	0032	FFFE	0002	0000	010C

Response example 2:

Since the D value is not proper, the data error occurs.

IWm+22	IWm+20	IWm+18	IWm+16	IWm+14	IWm+12	IWm+10	IWm+8
0000	0000	0000	0000	0000	0000	0000	4017



Since it is calculated on the presumption that the robot moves in the cartesian coordinate system, the SCARA robot does not move as expected.

*1: Single-axis controllers: PRM30, dual-axis controllers: PRM17

*2: Single-axis controllers: PRM44, dual-axis controllers: PRM64 and PRM104

(13) Position specification arch motion definition Code 010D

The arch motion of the position specification is defined.

Command option					
QWn+22	QWn+20	QWn+18	QWn+16	QWn+14	QWn+12
				Specified position	Axis

Command response					
IWm+22	IWm+20	IWm+18	IWm+16	IWm+14	IWm+12

(Details)

Axis: It is the execution axis number of the arch motion. 1 means X axis, and 2 means Y axis.

Specified position: It is the movement position (absolute position of origin reference) of the arch motion execution axis. The position can be specified in the range of -9999 to 9999 in the millimeter units.

(Example)

Transmission example 1:

The arch motion in which Y axis returns to Y=10.00 is defined.

QWn+22	QWn+20	QWn+18	QWn+16	QWn+14	QWn+12	QWn+10	QWn+8
0000	0000	0000	0000	000A	0002	0000	010D

Response example 1:

It is normally ended.

IWm+22	IWm+20	IWm+18	IWm+16	IWm+14	IWm+12	IWm+10	IWm+8
0000	0000	0000	0000	0000	0000	0000	0200



This command is invalid for single-axis controllers.

(14) Distance specification arch motion definition Code 010E

The arch motion of the distance specification is defined.

Command option					
QWn+22	QWn+20	QWn+18	QWn+16	QWn+14	QWn+12
				Specified distance	Axis

Command response					
IWm+22	IWm+20	IWm+18	IWm+16	IWm+14	IWm+12

(Details)

Axis: It is the execution axis number of the arch motion. 1 means X axis, and 2 means Y axis.

Specified distance:
It is the movement position (relative position of origin reference) of the arch motion execution axis.
The position can be specified in the range of -9999 to 9999 in the millimeter units.

(Example)

Transmission example 1:

The arch motion in which Y axis returns by -100.00 is defined.

QWn+22	QWn+20	QWn+18	QWn+16	QWn+14	QWn+12	QWn+10	QWn+8
0000	0000	0000	0000	FF9C	0002	0000	010E

Response example 1:

It is normally ended.

IWm+22	IWm+20	IWm+18	IWm+16	IWm+14	IWm+12	IWm+10	IWm+8
0000	0000	0000	0000	0000	0000	0000	0200

CAUTION

This command is invalid for single-axis controllers.

CAUTION

Since the current position on the program does not vary if the movement is interrupted due to the stop (interlock), etc., the movement can be continued by executing the command again. However, if resetting is executed, the current position on the program will be initialized at the position of the robot.

(15) General-purpose output or memory output status change Code 010F

ON/OFF control of the general-purpose output or memory output is performed.

Command option					
QWn+22	QWn+20	QWn+18	QWn+16	QWn+14	QWn+12
				Output status	DO/MO/SO number

Command response					
IWm+22	IWm+20	IWm+18	IWm+16	IWm+14	IWm+12

(Details)

DO/MO/SO number:

One is specified among the general-purpose output 0 to 12 (13 points)*, serial general-purpose output 200 to 231 (32 points) or memory output 100 to 131 (32 points).

Output status: 1 means ON, and 0 means OFF.

(Example)

Transmission example 1:

The serial general-purpose output 203 is turned ON.

QWn+22	QWn+20	QWn+18	QWn+16	QWn+14	QWn+12	QWn+10	QWn+8
0000	0000	0000	0000	0001	00CB	0000	010F

Response example 1:

It is normally ended.

IWm+22	IWm+20	IWm+18	IWm+16	IWm+14	IWm+12	IWm+10	IWm+8
0000	0000	0000	0000	0000	0000	0000	0200

* 0 to 4 (5 points) for the SRCP/SRCD series controllers

(16) General-purpose input or memory input wait Code 0110

It waits until the specified general-purpose input or memory input comes into the specified state.

Command option					
QWn+22	QWn+20	QWn+18	QWn+16	QWn+14	QWn+12
				Input status	DI/MI/SI number

Command response					
IWm+22	IWm+20	IWm+18	IWm+16	IWm+14	IWm+12

(Details)

DI/MI/SI number:

One is specified among the general-purpose input 0 to 15 (16 points)*, serial general-purpose input 200 to 231 (32 points) or memory input 100 to 147 (48 points).

Input status: 1 means ON, and 0 means OFF.

(Example)

Transmission example 1:

It waits until SI201=1.

QWn+22	QWn+20	QWn+18	QWn+16	QWn+14	QWn+12	QWn+10	QWn+8
0000	0000	0000	0000	0001	00C9	0000	0110

Response example 1:

It is normally ended.

IWm+22	IWm+20	IWm+18	IWm+16	IWm+14	IWm+12	IWm+10	IWm+8
0000	0000	0000	0000	0000	0000	0000	0200

* 0 to 7 (8 points) for the SRCP/SRCD series controllers

(17) Specified time waiting..... Code 0111

It waits for the specified time alone.

Command option					
QWn+22	QWn+20	QWn+18	QWn+16	QWn+14	QWn+12
					Time

Command response					
IWm+22	IWm+20	IWm+18	IWm+16	IWm+14	IWm+12

(Details)

Time: It can be specified in the range of 1 to 65535 in the 10 millisecond units.

(Example)

Transmission example 1:

It waits for 1 second.

QWn+22	QWn+20	QWn+18	QWn+16	QWn+14	QWn+12	QWn+10	QWn+8
0000	0000	0000	0000	0000	0064	0000	0111

Response example 1:

It is normally ended.

IWm+22	IWm+20	IWm+18	IWm+16	IWm+14	IWm+12	IWm+10	IWm+8
0000	0000	0000	0000	0000	0000	0000	0200

(18) Matrix definition Code 0112

The matrix is defined.

Command option					
QWn+22	QWn+20	QWn+18	QWn+16	QWn+14	QWn+12
			Pallet number	Line number	Array number

Command response					
IWm+22	IWm+20	IWm+18	IWm+16	IWm+14	IWm+12

(Details)

Array number, Line number:

A value of 1 to 255 can be applied to each matrix.

Pallet number:

It is the inherent number of 0 to 31 for the matrix discrimination.

(Example)

Transmission example 1:

The matrix of 5×2 is defined at the 1st number.

QWn+22	QWn+20	QWn+18	QWn+16	QWn+14	QWn+12	QWn+10	QWn+8
0000	0000	0000	0001	0002	0005	0000	0112

Response example 1:

It is normally ended.

IWm+22	IWm+20	IWm+18	IWm+16	IWm+14	IWm+12	IWm+10	IWm+8
0000	0000	0000	0000	0000	0000	0000	0200

(19) Movement matrix specification. Code 0113

The movement matrix is specified with the pallet work position specification movement execution command (code: 010C).

Command option					
QWn+22	QWn+20	QWn+18	QWn+16	QWn+14	QWn+12
					Pallet number

Command response					
IWm+22	IWm+20	IWm+18	IWm+16	IWm+14	IWm+12

(Details)

Pallet number: It is the inherent number of 0 to 31 for matrix discrimination.

(Example)

Transmission example 1:

The matrix of the pallet No. 0 is specified.

QWn+22	QWn+20	QWn+18	QWn+16	QWn+14	QWn+12	QWn+10	QWn+8
0000	0000	0000	0000	0000	0000	0000	0113

Response example 1:

It is normally ended.

IWm+22	IWm+20	IWm+18	IWm+16	IWm+14	IWm+12	IWm+10	IWm+8
0000	0000	0000	0000	0000	0000	0000	0200

(20) Point variable P definition Code 0114

The point variable P is set.

Command option					
QWn+22	QWn+20	QWn+18	QWn+16	QWn+14	QWn+12
					Point number

Command response					
IWm+22	IWm+20	IWm+18	IWm+16	IWm+14	IWm+12

(Details)

Point number: A value of 0 to 999 can be specified.

(Example)

Transmission example 1:

The point variable P is set to 100.

QWn+22	QWn+20	QWn+18	QWn+16	QWn+14	QWn+12	QWn+10	QWn+8
0000	0000	0000	0000	0000	0064	0000	0114

Response example 1:

It is normally ended.

IWm+22	IWm+20	IWm+18	IWm+16	IWm+14	IWm+12	IWm+10	IWm+8
0000	0000	0000	0000	0000	0000	0000	0200

MEMO

Since the point variable is prepared to treat the point number as the variable, a value of 0 to 999 can be specified.

CAUTION

Though the content of the point variable is held even if the controller power supply is turned OFF, the point variable is initialized to 0 if the program is reset or the execution program switch or other operation which the program reset is applied.

(21) Addition of specified value to point variable P Code 0115

The specified value is added to the point variable P.

Command option					
QWn+22	QWn+20	QWn+18	QWn+16	QWn+14	QWn+12
					Addition value

Command response					
IWm+22	IWm+20	IWm+18	IWm+16	IWm+14	IWm+12

(Details)

Addition value:

A value of 1 to 999 can be specified.

(Example)

Transmission example 1:

10 is added to the point variable P.

QWn+22	QWn+20	QWn+18	QWn+16	QWn+14	QWn+12	QWn+10	QWn+8
0000	0000	0000	0000	0000	000A	0000	0115

Response example 1:

It is normally ended.

IWm+22	IWm+20	IWm+18	IWm+16	IWm+14	IWm+12	IWm+10	IWm+8
0000	0000	0000	0000	0000	0000	0000	0200

(22) Subtraction of specified value from point variable P Code 0116

The specified value is subtracted from the point variable P.

Command option					
QWn+22	QWn+20	QWn+18	QWn+16	QWn+14	QWn+12
					Subtraction value

Command response					
IWm+22	IWm+20	IWm+18	IWm+16	IWm+14	IWm+12

(Details)

Subtraction value:

A value of 1 to 999 can be specified.

(Example)

Transmission example 1:

10 is subtracted from the point variable P.

QWn+22	QWn+20	QWn+18	QWn+16	QWn+14	QWn+12	QWn+10	QWn+8
0000	0000	0000	0000	0000	000A	0000	0116

Response example 1:

It is normally ended.

IWm+22	IWm+20	IWm+18	IWm+16	IWm+14	IWm+12	IWm+10	IWm+8
0000	0000	0000	0000	0000	0000	0000	0200

(23) Arrangement element specification of counter arrangement variable C Code 0117

The arrangement elements of the counter arrangement variable C used are specified.

Command option					
QWn+22	QWn+20	QWn+18	QWn+16	QWn+14	QWn+12
					Arrangement element No.

Command response					
IWm+22	IWm+20	IWm+18	IWm+16	IWm+14	IWm+12

(Details)

Arrangement element No.:

It expresses the inherent number of 0 to 31 to specify the arrangement element of the counter arrangement variable.

If 65534 (=FFFE (hexadecimal)) is input here, the value in the counter variable "D" is used to specify the element of the counter variable.

(Example)

Transmission example 1:

Hereafter, the counter arrangement variable of the element No. 1 is used.

QWn+22	QWn+20	QWn+18	QWn+16	QWn+14	QWn+12	QWn+10	QWn+8
0000	0000	0000	0000	0000	0001	0000	0117

Response example 1:

It is normally ended.

IWm+22	IWm+20	IWm+18	IWm+16	IWm+14	IWm+12	IWm+10	IWm+8
0000	0000	0000	0000	0000	0000	0000	0200

(24) Counter arrangement variable C specification Code 0118

The counter value is set at the counter arrangement variable C specified with the arrangement element specification command (code 0117).

Command option					
QWn+22	QWn+20	QWn+18	QWn+16	QWn+14	QWn+12
					Counter value

Command response					
IWm+22	IWm+20	IWm+18	IWm+16	IWm+14	IWm+12

(Details)

Counter value:

A value of 0 to 65535 can be specified.

(Example)

Transmission example 1:

200 is set at the counter arrangement variable C.

QWn+22	QWn+20	QWn+18	QWn+16	QWn+14	QWn+12	QWn+10	QWn+8
0000	0000	0000	0000	0000	00C8	0000	0118

Response example 1:

It is normally ended.

IWm+22	IWm+20	IWm+18	IWm+16	IWm+14	IWm+12	IWm+10	IWm+8
0000	0000	0000	0000	0000	0000	0000	0200

MEMO

The counter arrangement variable is the arrangement variable of 32 elements, and a desired number of 0 to 65535 can be set to each.

(25) Addition of specified value to counter arrangement variable C Code 0119

The specified value is added to the counter arrangement variable C specified with the arrangement element specification command (code 0117).

Command option					
QWn+22	QWn+20	QWn+18	QWn+16	QWn+14	QWn+12
					Addition value

Command response					
IWm+22	IWm+20	IWm+18	IWm+16	IWm+14	IWm+12

(Details)

Addition value:

A value of 1 to 65535 can be specified.

(Example)

Transmission example 1:

10 is added to the counter arrangement variable C.

QWn+22	QWn+20	QWn+18	QWn+16	QWn+14	QWn+12	QWn+10	QWn+8
0000	0000	0000	0000	0000	000A	0000	0119

Response example 1:

It is normally ended.

IWm+22	IWm+20	IWm+18	IWm+16	IWm+14	IWm+12	IWm+10	IWm+8
0000	0000	0000	0000	0000	0000	0000	0200

(26) Subtraction of specified value from counter arrangement variable C Code 011A

The specified value is subtracted from the counter arrangement variable C specified with the arrangement element specification command (code 0117).

Command option					
QWn+22	QWn+20	QWn+18	QWn+16	QWn+14	QWn+12
					Subtraction value

Command response					
IWm+22	IWm+20	IWm+18	IWm+16	IWm+14	IWm+12

(Details)

Addition value:

A value of 1 to 65535 can be specified.

(Example)

Transmission example 1:

10 is subtracted from the counter arrangement variable C.

QWn+22	QWn+20	QWn+18	QWn+16	QWn+14	QWn+12	QWn+10	QWn+8
0000	0000	0000	0000	0000	000A	0000	011A

Response example 1:

It is normally ended.

IWm+22	IWm+20	IWm+18	IWm+16	IWm+14	IWm+12	IWm+10	IWm+8
0000	0000	0000	0000	0000	0000	0000	0200

(27) Counter variable D definition Code 011B

The counter variable D is set.

Command option					
QWn+22	QWn+20	QWn+18	QWn+16	QWn+14	QWn+12
					Counter value

Command response					
IWm+22	IWm+20	IWm+18	IWm+16	IWm+14	IWm+12

(Details)

Counter value:

A value of 0 to 65535 can be specified.

(Example)

Transmission example 1:

200 is set to the counter variable D.

QWn+22	QWn+20	QWn+18	QWn+16	QWn+14	QWn+12	QWn+10	QWn+8
0000	0000	0000	0000	0000	00C8	0000	011B

Response example 1:

It is normally ended.

IWm+22	IWm+20	IWm+18	IWm+16	IWm+14	IWm+12	IWm+10	IWm+8
0000	0000	0000	0000	0000	0000	0000	0200

MEMO

The counter variable D is a variable which can be set as desired by the user, and a desired value of 0 to 65535 can be set.

(28) Addition of specified value to counter variable D Code 011C

The specified value is added to the counter variable D.

Command option					
QWn+22	QWn+20	QWn+18	QWn+16	QWn+14	QWn+12
					Addition value

Command response					
IWm+22	IWm+20	IWm+18	IWm+16	IWm+14	IWm+12

(Details)

Addition value:

A value of 1 to 65535 can be specified.

(Example)

Transmission example 1:

10 is added to the counter variable D.

QWn+22	QWn+20	QWn+18	QWn+16	QWn+14	QWn+12	QWn+10	QWn+8
0000	0000	0000	0000	0000	000A	0000	011C

Response example 1:

It is normally ended.

IWm+22	IWm+20	IWm+18	IWm+16	IWm+14	IWm+12	IWm+10	IWm+8
0000	0000	0000	0000	0000	0000	0000	0200

(29) Subtraction of specified value from counter variable D Code 011D

The specified value is subtracted from the counter variable D.

Command option					
QWn+22	QWn+20	QWn+18	QWn+16	QWn+14	QWn+12
					Subtraction value

Command response					
IWm+22	IWm+20	IWm+18	IWm+16	IWm+14	IWm+12

(Details)

Addition value:

A value of 1 to 65535 can be specified.

(Example)

Transmission example 1:

10 is subtracted from the counter variable D.

QWn+22	QWn+20	QWn+18	QWn+16	QWn+14	QWn+12	QWn+10	QWn+8
0000	0000	0000	0000	0000	000A	0000	011D

Response example 1:

It is normally ended.

IWm+22	IWm+20	IWm+18	IWm+16	IWm+14	IWm+12	IWm+10	IWm+8
0000	0000	0000	0000	0000	0000	0000	0200

(30) Shift execution of position data Code 011E

The position data is shifted by the specified point data. It is valid until this code is executed again or the program reset is applied.

Command option					
QWn+22	QWn+20	QWn+18	QWn+16	QWn+14	QWn+12
					Point number

Command response					
IWm+22	IWm+20	IWm+18	IWm+16	IWm+14	IWm+12

(Details)

Point number: It is the inherent number which is assigned to a total of 1000 points of 0 to 999. To specify the point variable P, register 4095 (=0FFF (hexadecimal)).

(Example)

Transmission example 1:

Hereafter, the position data is shifted by the data of the point 1 during movement.

QWn+22	QWn+20	QWn+18	QWn+16	QWn+14	QWn+12	QWn+10	QWn+8
0000	0000	0000	0000	0000	0001	0000	011E

Response example 1:

It is normally ended.

IWm+22	IWm+20	IWm+18	IWm+16	IWm+14	IWm+12	IWm+10	IWm+8
0000	0000	0000	0000	0000	0000	0000	0200

(31) Linear interpolation movement execution Code 011F

It moves to the position of the data of the specified point number in the linear interpolation mode.

Command option					
QWn+22	QWn+20	QWn+18	QWn+16	QWn+14	QWn+12
			Speed	Point number	Axis

Command response					
IWm+22	IWm+20	IWm+18	IWm+16	IWm+14	IWm+12

(Details)

Axis: In the linear interpolation movement, 0: All axes alone can be assigned.

Point number: It is the inherent number which is assigned to a total of 1000 points of 0 to 999. To specify the point variable P, register 4095 (=0FFF (hexadecimal)).

Speed: It can be set at 100 steps of 1 to 100, and when the program execution speed parameter*1 is 100, 100=1000mm/s is established. (When the maximum speed setting parameter*2 is 3000, and the lead length is 20mm.)

(Example)

Transmission example 1:

It moves to the P123 position at the speed 20% in the linear interpolation mode.

QWn+22	QWn+20	QWn+18	QWn+16	QWn+14	QWn+12	QWn+10	QWn+8
0000	0000	0000	0014	007B	0000	0000	011F

Response example 1:

It is normally ended.

IWm+22	IWm+20	IWm+18	IWm+16	IWm+14	IWm+12	IWm+10	IWm+8
0000	11CB	0000	13AD	0000	0000	0000	0200

Response example 2:

The software limit over occurs.

IWm+22	IWm+20	IWm+18	IWm+16	IWm+14	IWm+12	IWm+10	IWm+8
0000	0000	0000	0000	0000	0000	0000	401E

CAUTION

This command is invalid for single-axis controllers.

CAUTION

The SCARA robot, etc. which do not operate in the cartesian coordinates cannot be moved in the linear interpolation mode.

*1: Single-axis controllers: PRM30, dual-axis controllers: PRM17

*2: Single-axis controllers: PRM44, dual-axis controllers: PRM64 and PRM104

(32) Circular interpolation movement execution Code 0120

The circular interpolation movement which passes the specified point is executed. If the point specification number is n, it moves on the circular locus on which the current position is the start point, the point n is passed, and the point n+1 is the end point. If the circle is specified, it moves on the circle locus on which the current position is the start point, the points n and n+1 are passed, and the start point is the end point.

Command option					
QWn+22	QWn+20	QWn+18	QWn+16	QWn+14	QWn+12
			Locus specification	Speed	Point number

Command response					
IWm+22	IWm+20	IWm+18	IWm+16	IWm+14	IWm+12

(Details)

Point number: A point number of 0 to 998 can be specified. If the point variable P is specified, 4095(=0FFF (hexadecimal)) is registered.

Speed: It can be set at 100 steps of 1 to 100, and when the program execution speed parameter*1 is 100, 100=1000mm/s is established. (When the maximum speed setting parameter*2 is 3000, and the lead length is 20mm.)

Locus specification:

The locus type is selected. 0: Circular segment 1: Circle

(Example)

Transmission example 1:

It moves at the speed 20% on the circular locus where the start point is the current position, the point 123 is passed, and the point 124 is the end point.

QWn+22	QWn+20	QWn+18	QWn+16	QWn+14	QWn+12	QWn+10	QWn+8
0000	0000	0000	0000	007B	0001	0000	0120

Response example 1:

It is normally ended.

IWm+22	IWm+20	IWm+18	IWm+16	IWm+14	IWm+12	IWm+10	IWm+8
0000	0000	0000	0000	0000	0000	0000	0200

Transmission example 2:

It moves at the speed 5% on the circle locus where the start point is the current position, P100 and P101 are passed, and the start point is the end point.

QWn+22	QWn+20	QWn+18	QWn+16	QWn+14	QWn+12	QWn+10	QWn+8
0000	0000	0000	0001	0005	0064	0000	0120

Response example 2:

The software limit over occurs.

IWm+22	IWm+20	IWm+18	IWm+16	IWm+14	IWm+12	IWm+10	IWm+8
0000	0000	0000	0000	0000	0000	0000	401E

⚠ CAUTION

This command is invalid for single-axis controllers.

⚠ CAUTION

The applicable radius is max. 1000mm and min. 2mm.

⚠ CAUTION

The SCARA robot, etc. which do not operate in the cartesian coordinates cannot be moved in the circular interpolation mode.

*1: Single-axis controllers: PRM30, dual-axis controllers: PRM17

*2: Single-axis controllers: PRM44, dual-axis controllers: PRM64 and PRM104

2-12-4 Remote command details (data handling)

(1) Current position read Code 0201

The current positions of all axes or specified axes are read.

Command option					
QWn+22	QWn+20	QWn+18	QWn+16	QWn+14	QWn+12
					Axis

Command response					
IWm+22	IWm+20	IWm+18	IWm+16	IWm+14	IWm+12
Y axis position			X axis position		

(Details)

Axis: 0 means all axes, 1 means X axis and 2 means Y axis. On dual-axis controllers, all axes are also specified when 3 is set.

On single-axis controllers, 0 or 1 alone can be specified.

Axis position: The current position of the robot is indicated (unit: 0.01mm). When the robot is set at the rotary axis, the unit of the movement position is 0.01 degrees.

Single-axis controllers does not use IWm+20 to IWm+22.

Similarly, writing is not applied to the unspecified axis with the command option.

(Example)

Transmission example 1:

The current position information of all axes is read.

QWn+22	QWn+20	QWn+18	QWn+16	QWn+14	QWn+12	QWn+10	QWn+8
0000	0000	0000	0000	0000	0000	0000	0201

Response example 1:

The current position of the robot is X=321.05 and Y=100.15.

IWm+22	IWm+20	IWm+18	IWm+16	IWm+14	IWm+12	IWm+10	IWm+8
0000	271F	0000	7D69	0000	0000	0000	0200

CAUTION

Reset the current position indication mode, and execute the command.

MEMO

If any robot position cannot be judged due to the incomplete origin state, cable breakage, etc., the robot position is not determined.

(2) Current program number read Code 0202
 The execution program number is read.

Command option					
QWn+22	QWn+20	QWn+18	QWn+16	QWn+14	QWn+12

Command response					
IWm+22	IWm+20	IWm+18	IWm+16	IWm+14	IWm+12
					Program number

(Details)
 Program number:

It is the inherent number of 0 to 99 assigned to each program.

(Example)
 Transmission example 1:

The execution program is read.

QWn+22	QWn+20	QWn+18	QWn+16	QWn+14	QWn+12	QWn+10	QWn+8
0000	0000	0000	0000	0000	0000	0000	0202

Response example 1:

No. 31 is being executed.

IWm+22	IWm+20	IWm+18	IWm+16	IWm+14	IWm+12	IWm+10	IWm+8
0000	0000	0000	0000	0000	001F	0000	0200

(3) Current step number read Code 0203

The current step number is read.

Command option					
QWn+22	QWn+20	QWn+18	QWn+16	QWn+14	QWn+12

Command response					
IWm+22	IWm+20	IWm+18	IWm+16	IWm+14	IWm+12
					Step number

(Details)

Step number: It is the inherent value of 1 to 255 assigned to each step.

(Example)

Transmission example 1:

The execution step number is read.

QWn+22	QWn+20	QWn+18	QWn+16	QWn+14	QWn+12	QWn+10	QWn+8
0000	0000	0000	0000	0000	0000	0000	0203

Response example 1:

The 170th line is being executed.

IWm+22	IWm+20	IWm+18	IWm+16	IWm+14	IWm+12	IWm+10	IWm+8
0000	0000	0000	0000	0000	00AA	0000	0200

(4) Current task number read Code 0204

The task number currently selected is read.

Command option					
QWn+22	QWn+20	QWn+18	QWn+16	QWn+14	QWn+12

Command response					
IWm+22	IWm+20	IWm+18	IWm+16	IWm+14	IWm+12
					Task number

(Details)

Task number: It is the inherent number of 0 to 3 assigned to each task.

(Example)

Transmission example 1:

The execution task number is read.

QWn+22	QWn+20	QWn+18	QWn+16	QWn+14	QWn+12	QWn+10	QWn+8
0000	0000	0000	0000	0000	0000	0000	0204

Response example 1:

The currently selected task is 0 (main task).

IWm+22	IWm+20	IWm+18	IWm+16	IWm+14	IWm+12	IWm+10	IWm+8
0000	0000	0000	0000	0000	0000	0000	0200

(5) **Current point No. read** **Code 0205**

The point number currently selected is read.

Command option					
QWn+22	QWn+20	QWn+18	QWn+16	QWn+14	QWn+12

Command response					
IWm+22	IWm+20	IWm+18	IWm+16	IWm+14	IWm+12
					Point number

(Details)

Point number: It is the inherent value of 0 to 999 assigned to each point.

(Example)

Transmission example 1:

The current point number is read.

QWn+22	QWn+20	QWn+18	QWn+16	QWn+14	QWn+12	QWn+10	QWn+8
0000	0000	0000	0000	0000	0000	0000	0205

Response example 1:

The point number currently selected is 57.

IWm+22	IWm+20	IWm+18	IWm+16	IWm+14	IWm+12	IWm+10	IWm+8
0000	0000	0000	0000	0000	0039	0000	0200

MEMO

It is used to know what point number was used for movement or search for the point which causes an error if the error is caused by the point data.

(6) **ROM version number read Code 0206**

The controller system version value is read.

Command option					
QWn+22	QWn+20	QWn+18	QWn+16	QWn+14	QWn+12

Command response					
IWm+22	IWm+20	IWm+18	IWm+16	IWm+14	IWm+12
					Version value

(Details)

Version value: It is the system version which is possessed by the controller. If the version is V13.30, 1330 (=532 (hexadecimal)) is indicated.

(Example)

Transmission example 1:

The controller system version is read.

QWn+22	QWn+20	QWn+18	QWn+16	QWn+14	QWn+12	QWn+10	QWn+8
0000	0000	0000	0000	0000	0000	0000	0206

Response example 1:

The version is V13.30.

IWm+22	IWm+20	IWm+18	IWm+16	IWm+14	IWm+12	IWm+10	IWm+8
0000	0000	0000	0000	0000	0532	0000	0200

MEMO

The controller versions are as follows.

- ERCX/SRCX :V13.xx
- DRCX :V18.xx
- SRCP :V24.xx
- SRCD :V24.xxB
- SRCP30 :V24.xxH

(7) **Number of axes read Code 0207**

The total number of operable axes is read.

Command option					
QWn+22	QWn+20	QWn+18	QWn+16	QWn+14	QWn+12

Command response					
IWm+22	IWm+20	IWm+18	IWm+16	IWm+14	IWm+12
					Axis number

(Example)

Transmission example 1:

The total number of axes is read.

QWn+22	QWn+20	QWn+18	QWn+16	QWn+14	QWn+12	QWn+10	QWn+8
0000	0000	0000	0000	0000	0000	0000	0207

Response example 1:

2 axes are operable.

IWm+22	IWm+20	IWm+18	IWm+16	IWm+14	IWm+12	IWm+10	IWm+8
0000	0000	0000	0000	0000	0002	0000	0200

(8) Emergency stop status check..... Code 0208

The status of the emergency stop is read.

Command option					
QWn+22	QWn+20	QWn+18	QWn+16	QWn+14	QWn+12

Command response					
IWm+22	IWm+20	IWm+18	IWm+16	IWm+14	IWm+12
					Emergency stop

(Details)

Emergency stop:

1 means the emergency stop status, and 0 means that the emergency stop is canceled.

(Example)

Transmission example 1:

The status of the emergency stop is read.

QWn+22	QWn+20	QWn+18	QWn+16	QWn+14	QWn+12	QWn+10	QWn+8
0000	0000	0000	0000	0000	0000	0000	0208

Response example 1:

0 (the emergency stop is canceled.) is established.

IWm+22	IWm+20	IWm+18	IWm+16	IWm+14	IWm+12	IWm+10	IWm+8
0000	0000	0000	0000	0000	0000	0000	0200

(9) Servo status check..... Code 0209

The servo statuses of all axes or specified axes are read.

When all axes are specified, the result becomes 1 only if the servos of all axes are on.

Command option					
QWn+22	QWn+20	QWn+18	QWn+16	QWn+14	QWn+12
					Axis

Command response					
IWm+22	IWm+20	IWm+18	IWm+16	IWm+14	IWm+12
					Servo status

(Details)

Axis: 0 means all axes, 1 means X axis and 2 means Y axis. On dual-axis controllers, all axes are also specified when 3 is set.

On single-axis controllers, 0 or 1 alone can be specified.

Servo status: 1 means the servo-on and 0 means the servo-off.

(Example)

Transmission example 1:

The servo statuses of all axes are read.

QWn+22	QWn+20	QWn+18	QWn+16	QWn+14	QWn+12	QWn+10	QWn+8
0000	0000	0000	0000	0000	0000	0000	0209

Response example 1:

The servos of all axes are on.

IWm+22	IWm+20	IWm+18	IWm+16	IWm+14	IWm+12	IWm+10	IWm+8
0000	0000	0000	0000	0000	0001	0000	0200

(10) Return-to-origin status check Code 020A

It reads that the return-to-origin is completed in all axes or specified axes.

In three all-axis specification mode, the result becomes 1 only when all axes are completely returned to the origin.

Command option					
QWn+22	QWn+20	QWn+18	QWn+16	QWn+14	QWn+12
					Axis

Command response					
IWm+22	IWm+20	IWm+18	IWm+16	IWm+14	IWm+12
					Origin status

(Details)

Axis: 0 means all axes, 1 means X axis and 2 means Y axis. On dual-axis controllers, all axes are also specified when 3 is set.

On single-axis controllers, 0 or 1 alone can be specified.

Origin status: 0 means that the origin is incomplete, and 1 means that the return-to-origin is completed.

(Example)

Transmission example 1:

It reads that the return-to-origin is completed in all axes.

QWn+22	QWn+20	QWn+18	QWn+16	QWn+14	QWn+12	QWn+10	QWn+8
0000	0000	0000	0000	0000	0000	0000	020A

Response example 1:

The return-to-origin is completed in all axes.

IWm+22	IWm+20	IWm+18	IWm+16	IWm+14	IWm+12	IWm+10	IWm+8
0000	0000	0000	0000	0000	0001	0000	0200

(11) Service mode status check Code 020B

The service mode status is read.

Command option					
QWn+22	QWn+20	QWn+18	QWn+16	QWn+14	QWn+12

Command response					
IWm+22	IWm+20	IWm+18	IWm+16	IWm+14	IWm+12
					Status

(Details)

Status: 1 means that the servo mode is valid, and 0 means that it is invalid.

(Example)

Transmission example 1:

The service mode status is read.

QWn+22	QWn+20	QWn+18	QWn+16	QWn+14	QWn+12	QWn+10	QWn+8
0000	0000	0000	0000	0000	0000	0000	020B

Response example 1:

1 (service mode status) is established.

IWm+22	IWm+20	IWm+18	IWm+16	IWm+14	IWm+12	IWm+10	IWm+8
0000	0000	0000	0000	0000	0001	0000	0200

(12) Operation mode check..... Code 020C

The robot status is read.

Command option					
QWn+22	QWn+20	QWn+18	QWn+16	QWn+14	QWn+12

Command response					
IWm+22	IWm+20	IWm+18	IWm+16	IWm+14	IWm+12
					Operation mode

(Details)

Operation mode:

0: Stop status 1: The program is being executed with the communication of HPB, personal computer , etc. 2: The program is being executed with I/O command.

(Example)

Transmission example 1:

The robot status is read.

QWn+22	QWn+20	QWn+18	QWn+16	QWn+14	QWn+12	QWn+10	QWn+8
0000	0000	0000	0000	0000	0000	0000	020C

Response example 1:

0 (stop status) is established.

IWm+22	IWm+20	IWm+18	IWm+16	IWm+14	IWm+12	IWm+10	IWm+8
0000	0000	0000	0000	0000	0000	0000	0200

⚠ CAUTION

The data handling with the remote command is received during stop alone. Accordingly, the response of this mode is set to 0 (stop status) alone.

(13) Matrix definition content read Code 020D

The matrix definition content is read.

Command option					
QWn+22	QWn+20	QWn+18	QWn+16	QWn+14	QWn+12
					Pallet number

Command response					
IWm+22	IWm+20	IWm+18	IWm+16	IWm+14	IWm+12
				Line number	Array number

(Details)

Pallet number: It is the inherent number of 0 to 31 for matrix discrimination.

Array number, Line number:

It is the value of 1 to 255.

(Example)

Transmission example 1:

The data of the pallet No. 1 is read.

QWn+22	QWn+20	QWn+18	QWn+16	QWn+14	QWn+12	QWn+10	QWn+8
0000	0000	0000	0000	0000	0001	0000	020D

Response example 1:

It is the matrix of line number 20 and array number 30.

IWm+22	IWm+20	IWm+18	IWm+16	IWm+14	IWm+12	IWm+10	IWm+8
0000	0000	0000	0000	001E	0014	0000	0200

(14) Currently specified matrix number read Code 020E

The pallet number of the currently specified matrix is read.

Command option					
QWn+22	QWn+20	QWn+18	QWn+16	QWn+14	QWn+12

Command response					
IWm+22	IWm+20	IWm+18	IWm+16	IWm+14	IWm+12
					Pallet number

(Details)

Pallet number: It is the inherent number of 0 to 31 for matrix discrimination.

Array number, Line number:

It is the value of 1 to 255.

(Example)

Transmission example 1:

The currently specified pallet number is read.

QWn+22	QWn+20	QWn+18	QWn+16	QWn+14	QWn+12	QWn+10	QWn+8
0000	0000	0000	0000	0000	0000	0000	020E

Response example 1:

The pallet 0 is specified.

IWm+22	IWm+20	IWm+18	IWm+16	IWm+14	IWm+12	IWm+10	IWm+8
0000	0000	0000	0000	0000	0000	0000	0200

(15) Current point variable P read Code 020F

The point variable P is read.

Command option					
QWn+22	QWn+20	QWn+18	QWn+16	QWn+14	QWn+12

Command response					
IWm+22	IWm+20	IWm+18	IWm+16	IWm+14	IWm+12
					Point number

(Details)

Point number: It is the inherent number assigned to the point of 0 to 999.

(Example)

Transmission example 1:

The point variable P is read.

QWn+22	QWn+20	QWn+18	QWn+16	QWn+14	QWn+12	QWn+10	QWn+8
0000	0000	0000	0000	0000	0000	0000	020F

Response example 1:

The point variable is P=100

IWm+22	IWm+20	IWm+18	IWm+16	IWm+14	IWm+12	IWm+10	IWm+8
0000	0000	0000	0000	0000	0064	0000	0200

CAUTION

Though the content of the point variable P is held even when the controller power supply is turned off, the point variable P is initialized to 0 in case of the program reset or any operation which the program reset is applied with the execution program switch, etc.

(16) Arrangement element number read of currently specified C Code 0210

The element number of the counter arrangement variable C currently specified is read.

Command option					
QWn+22	QWn+20	QWn+18	QWn+16	QWn+14	QWn+12

Command response					
IWm+22	IWm+20	IWm+18	IWm+16	IWm+14	IWm+12
					Element No.

(Example)

Transmission example 1:

The element number of the counter arrangement variable C is read.

QWn+22	QWn+20	QWn+18	QWn+16	QWn+14	QWn+12	QWn+10	QWn+8
0000	0000	0000	0000	0000	0000	0000	0210

Response example 1:

The element No. is 31.

IWm+22	IWm+20	IWm+18	IWm+16	IWm+14	IWm+12	IWm+10	IWm+8
0000	0000	0000	0000	0000	001F	0000	0200

(17) Counter arrangement variable C read Code 0211

The value of the counter arrangement variable C of the specified element number is read.

Command option					
QWn+22	QWn+20	QWn+18	QWn+16	QWn+14	QWn+12
					Element No.

Command response					
IWm+22	IWm+20	IWm+18	IWm+16	IWm+14	IWm+12
					Counter value

(Details)

Element No.: The number specifies the arrangement element in the range of 0 to 31.

(Example)

Element No.: The value of the counter arrangement variable C is read.

QWn+22	QWn+20	QWn+18	QWn+16	QWn+14	QWn+12	QWn+10	QWn+8
0000	0000	0000	0000	0000	0000	0000	0211

Response example 1:

The element No. is 21202.

IWm+22	IWm+20	IWm+18	IWm+16	IWm+14	IWm+12	IWm+10	IWm+8
0000	0000	0000	0000	0000	52D2	0000	0200

(18) Current counter variable D read Code 0212

The value of the counter variable D is read.

Command option					
QWn+22	QWn+20	QWn+18	QWn+16	QWn+14	QWn+12

Command response					
IWm+22	IWm+20	IWm+18	IWm+16	IWm+14	IWm+12
					Counter value

(Example)

Transmission example 1:

The value of the counter variable D is read.

QWn+22	QWn+20	QWn+18	QWn+16	QWn+14	QWn+12	QWn+10	QWn+8
0000	0000	0000	0000	0000	0000	0000	0212

Response example 1:

The element No. is 65535.

IWm+22	IWm+20	IWm+18	IWm+16	IWm+14	IWm+12	IWm+10	IWm+8
0000	0000	0000	0000	0000	FFFF	0000	0200

(19) Current shift data read Code 0213

The currently set shift data is read.

Command option					
QWn+22	QWn+20	QWn+18	QWn+16	QWn+14	QWn+12

Command response					
IWm+22	IWm+20	IWm+18	IWm+16	IWm+14	IWm+12
Y axis position			X axis position		

(Details)

Axis position: The shift data is indicated (unit: 0.01mm). When the robot is set at the rotary axis, the unit of the position is 0.01 degrees.

Single-axis controllers does not use IWm+20 to IWm+22.

(Example)

Transmission example 1:

The current shift data is read.

QWn+22	QWn+20	QWn+18	QWn+16	QWn+14	QWn+12	QWn+10	QWn+8
0000	0000	0000	0000	0000	0000	0000	0213

Response example 1:

The shift data is X=150.00, Y=250.00.

IWm+22	IWm+20	IWm+18	IWm+16	IWm+14	IWm+12	IWm+10	IWm+8
0000	61A8	0000	3A98	0000	0000	0000	0200

(20) General-purpose input and memory input status read Code 0214

The status of the general-purpose input or memory input is read.

Command option					
QWn+22	QWn+20	QWn+18	QWn+16	QWn+14	QWn+12
					DI/MI/SI number

Command response					
IWm+22	IWm+20	IWm+18	IWm+16	IWm+14	IWm+12
					Input status

(Details)

DI/SI/MI number:

One number is specified among the general-purpose input 0 to 15 (16 points)*, memory input 100 to 147 (48 points) and serial general-purpose input 200 to 231 (32 points).

Input status: 1 means ON, and 0 means OFF.

(Example)

Transmission example 1:

The status of SI201 is read.

QWn+22	QWn+20	QWn+18	QWn+16	QWn+14	QWn+12	QWn+10	QWn+8
0000	0000	0000	0000	0000	00C9	0000	0214

Response example 1:

The SI201 status is SI201=1(ON).

IWm+22	IWm+20	IWm+18	IWm+16	IWm+14	IWm+12	IWm+10	IWm+8
0000	0000	0000	0000	0000	0001	0000	0200

* 0 to 7 (8 points) for the SRCP/SRCD series controllers

(21) General-purpose output and memory output status read Code 0215

The status of the general-purpose output or memory output is read.

Command option					
QWn+22	QWn+20	QWn+18	QWn+16	QWn+14	QWn+12
					DO/MO/SO number

Command response					
IWm+22	IWm+20	IWm+18	IWm+16	IWm+14	IWm+12
					Output status

(Details)

DO/SO/MO number:

One number is specified among the general-purpose output 0 to 12 (13 points)*, memory output 100 to 131 (32 points) and serial general-purpose output 200 to 231 (32 points).

Output status: 1 means ON, and 0 means OFF.

(Example)

Transmission example 1:

The status of SO202 is read.

QWn+22	QWn+20	QWn+18	QWn+16	QWn+14	QWn+12	QWn+10	QWn+8
0000	0000	0000	0000	0000	00CA	0000	0215

Response example 1:

The SO202 status is SO202=0(OFF).

IWm+22	IWm+20	IWm+18	IWm+16	IWm+14	IWm+12	IWm+10	IWm+8
0000	0000	0000	0000	0000	0000	0000	0200

* 0 to 4 (5 points) for the SRCP/SRCD series controllers

(22) Specified parameter data read Code 0216

The specified parameter data is read.

Command option					
QWn+22	QWn+20	QWn+18	QWn+16	QWn+14	QWn+12
					Parameter number

Command response					
IWm+22	IWm+20	IWm+18	IWm+16	IWm+14	IWm+12
					Parameter value

(Details)

Parameter number:

The inherent number assigned to each parameter is 0 to 63 for single-axis controllers, and is 0 to 127 for dual-axis controllers.

(Example)

Transmission example 1:

Y-axis transfer mass parameter (PRM90) is read.

QWn+22	QWn+20	QWn+18	QWn+16	QWn+14	QWn+12	QWn+10	QWn+8
0000	0000	0000	0000	0000	005A	0000	0216

Response example 1:

The parameter is PRM90=5(kg).

IWm+22	IWm+20	IWm+18	IWm+16	IWm+14	IWm+12	IWm+10	IWm+8
0000	0000	0000	0000	0000	0005	0000	0200

(23) Specified point data read..... Code 0217

The specified point data is read.

Command option					
QWn+22	QWn+20	QWn+18	QWn+16	QWn+14	QWn+12
					Point number

Command response					
IWm+22	IWm+20	IWm+18	IWm+16	IWm+14	IWm+12
Y axis position			X axis position		

(Details)

Point number: It is the inherent number of 0 to 999 assigned to each point.

(Example)

Transmission example 1:

Data of P254 is read.

QWn+22	QWn+20	QWn+18	QWn+16	QWn+14	QWn+12	QWn+10	QWn+8
0000	0000	0000	0000	0000	00FE	0000	0217

Response example 1:

The shift data is X=-0.05, Y=0.01.

IWm+22	IWm+20	IWm+18	IWm+16	IWm+14	IWm+12	IWm+10	IWm+8
0000	0001	FFFF	FFFB	0000	0000	0000	0200

2-12-5 Remote command details (utilities)

(1) Execution program number switching Code 0301

The execution program number is switched. If the program reset is hereafter executed, it will return to the 1st step of the program selected here.
 When this command is issued, the program reset will be applied.

Command option					
QWn+22	QWn+20	QWn+18	QWn+16	QWn+14	QWn+12
					Program number

Command response					
IWm+22	IWm+20	IWm+18	IWm+16	IWm+14	IWm+12

(Details)

Program number:

It is the inherent number of 0 to 99 assigned to each program.

(Example)

Transmission example 1:

The program is switched to NO31.

QWn+22	QWn+20	QWn+18	QWn+16	QWn+14	QWn+12	QWn+10	QWn+8
0000	0000	0000	0000	0000	001F	0000	0301

Response example 1:

It is normally ended.

IWm+22	IWm+20	IWm+18	IWm+16	IWm+14	IWm+12	IWm+10	IWm+8
0000	0000	0000	0000	0000	0000	0000	0200

(2) Execution task number switching. Code 0302

The execution task number is switched. If the step operation is hereafter executed, the program of the task selected here will be executed as one step.

Command option					
QWn+22	QWn+20	QWn+18	QWn+16	QWn+14	QWn+12
					Task number

Command response					
IWm+22	IWm+20	IWm+18	IWm+16	IWm+14	IWm+12

(Details)

Task number: It is the inherent number of 0 to 3 assigned to each task.

(Example)

Transmission example 1:

Task is switched to 1.

QWn+22	QWn+20	QWn+18	QWn+16	QWn+14	QWn+12	QWn+10	QWn+8
0000	0000	0000	0000	0000	0001	0000	0302

Response example 1:

The specified task is not executed.

IWm+22	IWm+20	IWm+18	IWm+16	IWm+14	IWm+12	IWm+10	IWm+8
0000	0000	0000	0000	0000	0000	0000	4048

(3) Parameter data write Code 0303

Data is written into the specified parameter.

Command option					
QWn+22	QWn+20	QWn+18	QWn+16	QWn+14	QWn+12
Parameter data					Parameter number

Command response					
IWm+22	IWm+20	IWm+18	IWm+16	IWm+14	IWm+12

(Details)

Parameter number:

The inherent number assigned to each parameter is 0 to 63 for single-axis controllers, and is 0 to 127 for dual-axis controllers.

Parameter data:

For the parameter data, refer to "Chapter 5 Parameters" of each controller manual.

(Example)

Transmission example 1:

The Y-axis transfer mass parameter (PRM90) is set to 3 kilograms.

QWn+22	QWn+20	QWn+18	QWn+16	QWn+14	QWn+12	QWn+10	QWn+8
0000	0000	0000	0003	0000	005A	0000	0303

Response example 1:

It is normally ended.

IWm+22	IWm+20	IWm+18	IWm+16	IWm+14	IWm+12	IWm+10	IWm+8
0000	0000	0000	0000	0000	0000	0000	0200

(4) Point data write..... Code 0304

The data is written into the specified point.

Command option					
QWn+22	QWn+20	QWn+18	QWn+16	QWn+14	QWn+12
Y axis position		X axis position		Axis	Point number

Command response					
IWm+22	IWm+20	IWm+18	IWm+16	IWm+14	IWm+12

(Details)

Point number: It is the inherent number of 0 to 999 assigned to each point.

Axis: 0 means all axes, 1 means X axis and 2 means Y axis. On dual-axis controllers, all axes are also specified when 3 is set.

On single-axis controllers, 0 or 1 alone can be specified.

Axis data: The position data desired to register is directly specified (Unit: 0.01 mm). When the rotary axis is set for the robot, the unit of the movement position is 0.01 degrees. If any axis is specified, the data of other axes not specified is free. It does not matter that the data of Y axis is free in single-axis controllers.

(Example)

Transmission example 1:

X=25.00 and Y=10.00 are written into P100.

QWn+22	QWn+20	QWn+18	QWn+16	QWn+14	QWn+12	QWn+10	QWn+8
0000	03E8	0000	09C4	0000	0064	0000	0304

Response example 1:

It is normally ended.

IWm+22	IWm+20	IWm+18	IWm+16	IWm+14	IWm+12	IWm+10	IWm+8
0000	0000	0000	0000	0000	0000	0000	0200

2-12-6 Remote command details (Special commands)

- (1) **No execution (status clear) Code 0000**
The status is cleared to 0000 for the command ready (remote command acceptable status).
- (2) **Initialization of response register Code 0401**
The command option register is copied to the response register. If 0000 (hexadecimal) is set to QWn+12 to QWn+22, the response will be initialized.

Command option					
QWn+22	QWn+20	QWn+18	QWn+16	QWn+14	QWn+12
Copy source data					
Command response					
IWm+22	IWm+20	IWm+18	IWm+16	IWm+14	IWm+12
Copy destination data					

(Details)

Copy data: The data in the option register QWn+12 to QWn+22 is copied to IWm+12 to IWm+22.

(Example)

Transmission example 1:

The response register is initialized.

QWn+22	QWn+20	QWn+18	QWn+16	QWn+14	QWn+12	QWn+10	QWn+8
0000	0000	0000	0000	0000	0000	0000	0401

Response example 1:

It is normally ended.

IWm+22	IWm+20	IWm+18	IWm+16	IWm+14	IWm+12	IWm+10	IWm+8
0000	0000	0000	0000	0000	0000	0000	0200

2-12-7 Status details

When the controller receives the command, the relevant process will be executed, and the result (status) will be informed to the master sequencer (PLC) side via I_{Wm}+8. The meanings indicated with the statuses are described in this section.

Code 0000 Command ready

It indicates that the remote command is not executed and can be newly received. When the command is issued to the controller, the status must be surely 0000. Here, 0000 is set to Q_{Wn}+8 in order to set 0000 to the status.

Code 0100 Command executing

It indicates that the controller receives the remote command and is on the way of the execution.

* If the reset command or other command of a short execution time is executed, the code 0100 can sometimes not be detected on the sequencer (PLC) side due to the scan time (10 milliseconds) on the controller side. Take sufficient care to assemble the sequence program.

Code 0200 Normal end of command

It indicates that the controller normally completes the remote command.

Code 40xx Command error occurrence

It indicates that an error occurs and the execution of the remote command cannot be normally completed.

The occurrence error number is set at the area of xx.

For example, if the 403E code is sent to the sequencer (PLC) side, it indicates from 3E (hexadecimal) = 62 (decimal) that the command is interrupted by the interlock from I/O.

* For the error numbers, refer to "Message tables" in "Instruction Manual for Controller".

Code 80xx (81xx) X (Y)axis alarm occurrence

It indicates that an alarm occurs in the controller. If any alarm occurs at the X axis, 80xx will be sent to the sequencer (PLC) side, and if it occurs at the Y axis, 81xx will be sent to the sequencer (PLC) side. The occurrence alarm number will be set at the xx area.

For example, if the 800F code is sent to the sequencer (PLC) side, it indicates from 0F (hexadecimal) = 15 (decimal) that the alarm of the feed back error 2 occurs.

* To cancel the alarm, it is necessary to turn off the controller power supply. For the alarm number and alarm treatment method, refer to "Troubleshooting" in "Instruction Manual for Controller".

2-12-8 Current position indication mode

The current position indication mode is selected by setting 0001 to QWn+10.

In the current position indication mode, the current position of the robot is always output to IWm+16 to IWm+22 regardless of the execution status or no-execution status of the remote command. The position of the robot can be always grasped by selecting the current position indication mode.

Remote command		Meaning of command
RWwn+1	RWwn	
0001	xxxx	Current position information is displayed in IWrn+16 to IWrn+22.

Command response					
IWm+22	IWm+20	IWm+18	IWm+16	IWm+14	IWm+12
Y axis position			X axis position		

(Details)

Axis position: The current position of the robot is indicated (unit: 0.01mm). If the rotary axis is set for the robot, the unit of the movement position is 0.01 degrees.

IWm+20 to IWm+22 is not used in single-axis controllers.

(Example)

Transmission example 1:

Current position is output by current position display mode.

QWn+22	QWn+20	QWn+18	QWn+16	QWn+14	QWn+12	QWn+10	QWn+8
0000	0000	0000	0000	0000	0000	0001	0000

Response example 1:

The current position of the robot is X=321.05 and Y=-0.02.

IWm+22	IWm+20	IWm+18	IWm+16	IWm+14	IWm+12	IWm+10	IWm+8
FFFF	FFFE	0000	7D69	0000	0000	0000	0000

Transmission example 2:

Move to the position of X=50.37 and Y=45.55 at the 100% speed in the current position indication mode.

QWn+22	QWn+20	QWn+18	QWn+16	QWn+14	QWn+12	QWn+10	QWn+8
0000	11CB	0000	13AD	0064	0000	0001	0108

Response example 2:

Moving to the target position is normally ended. (The current position of the robot is X=50.37 and Y=45.55)

IWm+22	IWm+20	IWm+18	IWm+16	IWm+14	IWm+12	IWm+10	IWm+8
0000	11CB	0000	13AD	0000	0000	0000	0200

CAUTION

Before executing a command which uses IWm+16 to IWm+22 as the response such as the specified point data read command (code 0217), cancel the current position indication mode. If the current position indication mode is kept, the command response overlaps with the current position indication and the data cannot be normally read out.

Do not use the current position indication mode when executing a command which uses IWm+16 to IWm+22 as the response.

MEMO

The renewal interval of the current position is every 10 milliseconds. Accordingly, when the robot moves at a high speed, the error becomes large between the actual position of the robot and the robot position sent as the response.

MEMO

 If the robot position cannot be judged due to the incomplete origin position status, cable breakage, etc., the robot position will not be determined.

2-12-9 Sending/receiving example

The sending/receiving example is shown when the direct position specification movement execution (code 0108). (Values are expressed in the hexadecimal mode.)

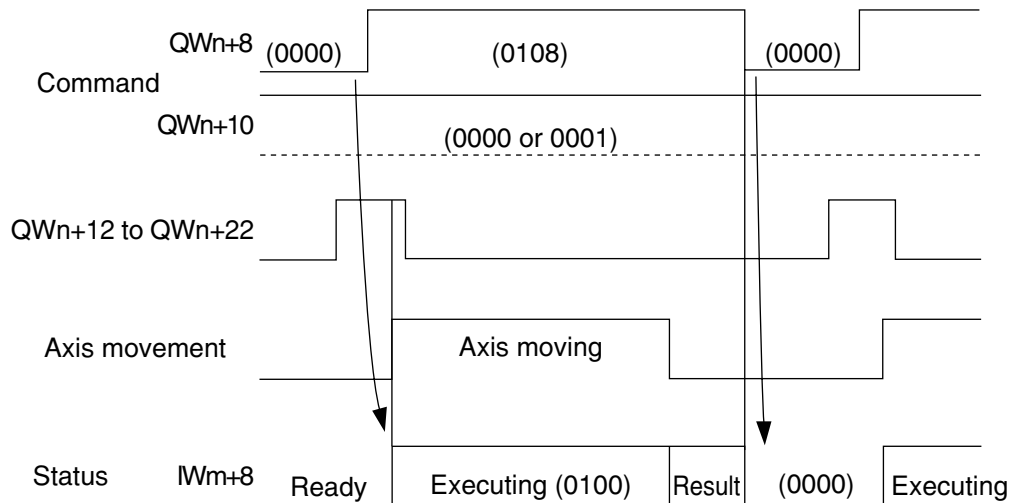

- (1) The direct position specification movement execution command is executed by setting 0108 to QWn+8. Here, the options (movement axis, speed, target position) necessary for movement are set at the specified addresses in QWn+12 to QWn+22 before the command is set to QWn+8 or at the same time when the command is set.
 0000 is usually set to QWn+10, and 0001 is set to execute the command in the current position indication mode. (In the current position indication mode, the following process is executed with the current position indicated at IWm+16 to IWm+22.)
- (2) When the controller receives the command, it starts the axis movement together with 0100 return to IWm+8. When the status is changed into the execution status, it does not matter that QWn+12 to QWn+22 (command option) is changed.
- (3) When the movement is completed, the result is set to IWm+8. If it is normally completed, 0200 is set.
- (4) When 0000 is set to QWn+8, the status is cleared. This ends the cycle of the command execution.
 Here, after verifying that the status becomes 0000, issue the next command.

2-13 Other operations

2-13-1 Serial I/O display

Serial I/O (input/output) status can be displayed on the screen. Both initial screen and OPRT screen are used for display.

- 1) Press **[F4]** (MON) on the initial screen.

```
[MENU]
select menu

1EDIT2OPRT3SYS 4MON
```

- 2) Since the parallel input/output state continues displayed, press **[DIO]** here.

For the display meaning of the parallel input/output status, refer to "How to see the screen" in "Instruction Manual for Controller".

```
DI  10000000 00000000
      10000000
DO  00000000 10100000
XO:1 YO:1 XS:1 YS:1
```

- 3) The serial input/output statuses of Qn+1.7 to Qn.0, Qn+3.7 to Qn+2.0, Im+1.7 to Im.0 and Im+3.7 to Im+2.0 are continuously displayed from the upper row.

```
SI  10000000 10000000
      00000000 00000000
SO  10100000 01000001
      00000000 00000000
```

- 4) Press **[DIO]** above in 3), and the display will be switched to the serial input/output status display of Qn+5.7 to Qn+4.0, Qn+7.7 to Qn+6.0, Im+5.7 to Im+4.0 and Im+7.7 to Im+6.0.

```
SI  00000000 00000000
      00000000 00000000
SO  00001000 00000000
      00000000 00000000
```

- 5) Press **[DIO]** (above in 4), and the screen will be switched to the remote register mode. Each remote register will be displayed in the hexadecimal mode. (Each register is indicated with 4 characters.)

```

WI  00000000 00000000
      FFFF1000 00000000
WO  00000000 00000000
      00000000 00000000
    
```

The top row displays the statuses of QWn+14, QWn+12, QWn+10 and QWn+8 from the left.

The 2nd row indicates the statuses of QWn+22, QWn+20, QWn+18 and QWn+16 from the left.

The 3rd row indicates the statuses of IWm+14, IWm+12, IWm+10 and IWm+8 from the left.

The bottom row indicates the statuses of IWm+22, IWm+20, IWm+18 and IWm+16 from the left.

- 6) Press **[DIO]** above in 5), and the screen will be switched to the parallel input/output status mode again. Hereafter, each push of **[DIO]** will switch the screen. To return to the original screen, press **(ESC)**.

```

[MENU]
select menu

1EDIT2OPRT3SYS 4MON
    
```

- 7) Press **[F2]** (OPRT) in the initial screen to display the serial input/output statuses in the OPRT screen.

```

[MENU]
select menu

1EDIT2OPRT3SYS 4MON
    
```

- 8) Press **[F2]** (STEP) or **[F3]** (AUTO). The step operation screen is explained in the subsequent steps.

```

[OPRT]
select menu

1ORG 2STEP3AUTO
    
```

- 9) Press **[F4]** (next) 2 times to switch to the function table, and then press **[F2]** (SIO).

```

[OPRT-STEP] 100 0: 0
001:MOVA 254,100
[ 0.00, 0.00]
1MIO 2SIO 3 4next
    
```

- 10) Press **F1** (SI01) to display the Qn+3.7 to Qn.0 and Im+3.7 to Im.0 status. Press **F2** (SI02) to display the Qn+7.7 to Qn+4.0 and Im+7.7 to Im+4.0. Press **F3** (WIO) to display the status of the remote register.

```
[OPRT-STEP] 100 0: 0
001:MOVA 254,100
[ 0.00, 0.00]
1SI012SI023WIO
```

- 11) Continue displaying the status of each serial I/O.

If **F1** (SI01) was pressed above in step 10), then the Qn+1.7 to Qn.0, Qn+3.7 to Qn+2.0, Im+1.7 to Im.0 and Im+3.7 to Im+2. status is displayed from the upper row.

If **F2** (SI02) was pressed above in step 10), then the Qn+5.7 to Qn+4.0, Qn+7.7 to Qn+6.0, Im+5.7 to Im+4.0 and Im+7.7 to Im+6. status is displayed from the upper row.

```
SI 00000000 00000000
    00000000 00000000
SO 00000000 00000000
    00000000 00000000
```

- 12) This is the screen when **F3** (WIO) is pressed.

Each remote register will be displayed in the hexadecimal mode.

(Each register is indicated with 4 characters.)

The top row displays the statuses of QWn+14, QWn+12, QWn+10 and QWn+8 from the left.

The 2nd row indicates the statuses of QWn+22, QWn+20, QWn+18 and QWn+16 from the left.

The 3rd row indicates the statuses of IWm+14, IWm+12, IWm+10 and IWm+8 from the left.

The bottom row indicates the statuses of IWm+22, IWm+20, IWm+18 and IWm+16 from the left.

```
WI 00000000 00000000
    FFFF1000 00000000
WO 00000000 00000000
    00000000 00000000
```

- 13) Press the **ESC** key to return to the screen in step 10).

```
[OPRT-STEP] 100 0: 0
001:MOVA 254,100
[ 0.00, 0.00]
1SI012SI023WIO
```

2-13-2 Manual control of general-purpose output

The serial general-purpose output can be manually controlled from HPB.

- 1) Press **F1** (EDIT) on the initial screen.

```
[MENU]
select menu

1EDIT2OPRT3SYS 4MON
```

- 2) Press **F2** (PNT).

```
[MENU]
select menu

1PGM 2PNT 3UTL
```

- 3) Press **F2** (TCH) or **F3** (DTCH).

The teaching play back screen is explained in the subsequent steps.

```
[EDIT-PNT]
select menu

1MDI 2TCH 3DTCH4DEL
```

- 4) During movement of the robot, it reaches the position where the general-purpose output is desired for operation. At this time, stop the operation once, and press **F2** (DO).

```
[EDIT-PNT-TCH] (1) 50
P0 X=0.00 [mm]
[ 0.00, 0.00]
1CHG 2DO 3Y 4next
```

- 5) The current status of the general-purpose output appears on the screen. Just press **F4** (next) as many times as needed to select SO200 to SO231.

Press the function key displaying the SO number desired to control to highlight the output status.

```
[EDIT-PNT-TCH] (1) 50
SO 200=0 201=0 202=0
SO 203=0 204=0 205=0
1S2002S2013S2024next
```

- 6) To return to the screen in step 4), press **ESC**.

```
[EDIT-PNT-TCH] (1) 50
P0 X=0.00 [mm]
[ 0.00, 0.00]
1CHG 2DO 3Y 4next
```

* The manual control is invalid on the port that used emulated serialization on a parallel I/O.

2-14 Error Message

Regarding PROFIBUS system, the following error message is added.

Error No. 38	Message	net link error
	Cause	connection was forcibly disconnected because an error occurred in the network connection.
	Remedy	Remedy the network connection error, and then restart.

2-15 Troubleshooting

Check the following items if any problems occur during operation. Also, refer to “Troubleshooting” in the controller instruction manual and always refer to the section on troubleshooting in the master station sequencer (PLC) instruction manual. If the following items do not eliminate the problem, promptly contact your Yamaha dealer or Yamaha for assistance.

No.	Symptom	Causes	Checkpoints	Remedy
1	When using the master station sequencer line test function, unable to verify from the master station sequencer (PLC), that the robot controller is correctly connected to the PROFIBUS system.	1) PROFIBUS cable not correctly connected.	<ul style="list-style-type: none"> Check if PROFIBUS cable is not connected, is miswired, or wires are broken. 	<ul style="list-style-type: none"> Correctly repair any miswirings or unconnected wiring. Replace the cable if broken.
		2) PROFIBUS unit is not validated so cannot be identified from controller.	<ul style="list-style-type: none"> Refer to “2-5-1 Validating the PROFIBUS unit”, and check that the PROFIBUS unit is properly validated. 	<ul style="list-style-type: none"> Validate the PROFIBUS unit, and turn on the controller power again.
		3) Station address setting is incorrect.	<ul style="list-style-type: none"> Refer to “2-5-2 Setting the station address” and check the station address. 	<ul style="list-style-type: none"> Reset the station address correctly, and turn on the controller power again.
		4) Alarm occurring on controller.	<ul style="list-style-type: none"> Connect the HPB and check for an alarm. Check if the status LED is lit in red. 	<ul style="list-style-type: none"> Refer to the controller instruction manual and troubleshoot according to the particular alarm.
		5) PROFIBUS cable length does not meet specifications for the PROFIBUS, or a terminating resistor is not connected.	<ul style="list-style-type: none"> Check the PROFIBUS cable wiring. 	<ul style="list-style-type: none"> Repair the wiring.
		6) PROFIBUS cable is in proximity to a noise source such as motor/power lines.	<ul style="list-style-type: none"> Check the PROFIBUS cable installation. 	<ul style="list-style-type: none"> Reinstall the PROFIBUS unit away from the source of noise (motor/power lines.)
		7) PROFIBUS unit is defective.	<ul style="list-style-type: none"> Replace the PROFIBUS unit. 	<ul style="list-style-type: none"> If this solves the problem, replace the PROFIBUS unit.
2	Servo won't turn on.	1) Set to emergency stop with Qn+1.7 at OFF.	<ul style="list-style-type: none"> Check Qn+1.7 status. 	<ul style="list-style-type: none"> To turn on the servo (servo-on) set Qn+1.7 to ON.
		2) Set to emergency stop from HPB or external parallel I/O.	<ul style="list-style-type: none"> Check if set to emergency stop at HPB or external parallel I/O. 	<ul style="list-style-type: none"> Cancel emergency stop on the HPB or external parallel I/O in order to set the servo to on (servo-on).
		3) Controller alarm was issued.	<ul style="list-style-type: none"> Connect the HPB and check the alarm that was issued. Status LED is lit up in red. 	<ul style="list-style-type: none"> Refer to the controller instruction manual and troubleshoot per the particular alarm.

(continued to next page)

No.	Symptom	Causes	Checkpoints	Remedy
3	Program stops by itself during automatic operation.	1) Error occurred on the PROFIBUS system during communication. 2) Controller is defective.	<ul style="list-style-type: none"> • Check if an error has occurred by monitoring the network status information on master PLC. • Referring to “2-5-1 Validating the PROFIBUS unit”, invalidate the PROFIBUS unit and try operating the robot separately with the controller. 	<ul style="list-style-type: none"> • Check for any problems with noise or the wiring specifications, and eliminate factors causing errors on the PROFIBUS system. • If the program stops by itself even during independent controller operation, then the controller is probably defective, so replace the controller.

2-16 Specifications

Spec. Item	Model	PROFIBUS Unit
Controller models		SRCP/SRCD/ERCX/SRCX/DRCX series controllers
Communication profile		PROFIBUS-DP slave
Number of occupied nodes		1 node
Station address setting		0 to 126 (Address is set from HPB.)
Communication speed		9.6K/19.2K/93.75K/187.5K/500K/1.5M/3M/6M/12Mbps (automatic recognition)
PROFIBUS I/O points *		General-purpose inputs 32 points General-purpose outputs 32 points Custom inputs 16 points Custom outputs 16 points Input register 8 words (not currently used) Output register 8 words (not currently used)
Parallel external I/O		All points usable as parallel external I/O for controller Each point controllable from master station sequencer (PLC) by emulated serialization, regardless of robot program.
Overall length		100m (12Mbps) 200m (1.5Mbps) 400m (500Kbps) 1000m (187.5Kbps) 1200m (9.6K/19.2K/93.75Kbps)

* Controller I/O rewrite period is every 10ms.

NOTE: The product external appearance and specifications are subject to change without prior notice for purposes of improvement or other factors.

2-17 Supplement

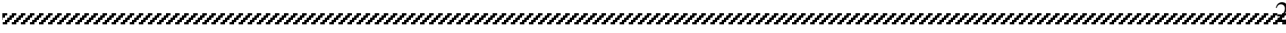

2-17-1 GSD files

The contents of GSD file 1 are shown below just for your reference.

```

*****
;*
;* GSD File for SRCP/SRCD/ERCX/SRCX/DRCX series
;*
;*                                ROBOT CONTROLLER
;*
;* Version : 1.00
;* Date   : January 1, 2004
;*
;* (C) Copyright YAMAHA MOTOR CO.,LTD. 2004,
;* All Right Reserved
;*
;* YAMAHA MOTOR CO.,LTD.
;*
*****

#Profibus_DP
GSD_Revision      = 1
Vendor_Name       = "YAMAHA MOTOR CO.,LTD."
Model_Name        = "SRCP/SRCD/ERCX/SRCX/DRCX series"
Ident_Number      = 0x082C
FMS_supp          = 0
Protocol_Ident    = 0
Station_Type      = 0
Slave_Family      = 5
Revision          = "Ver1.0"
Hardware_Release  = "Ver1.0"
Software_Release  = "Ver1.2"

;-----
Redundancy        = 0
Repeater_Ctrl_Sig = 2
24V_Pins          = 0
;-----

```

```

Auto_Baud_supp      = 1                ; Supported
;
9.6_supp           = 1                ; 9.6kbps
19.2_supp          = 1                ; 19.2kbps
93.75_supp         = 1                ; 93.75kbps
187.5_supp        = 1                ; 187.5kbps
500_supp           = 1                ; 500kbps
1.5M_supp          = 1                ; 1.5Mbps
3M_supp            = 1                ; 3Mbps
6M_supp            = 1                ; 6Mbps
12M_supp           = 1                ; 12Mbps
; Max. response times:
MaxTsdr_9.6        = 15              ;
MaxTsdr_19.2       = 15              ;
MaxTsdr_93.75      = 15              ;
MaxTsdr_187.5      = 15              ;
MaxTsdr_500        = 15              ;
MaxTsdr_1.5M       = 25              ;
MaxTsdr_3M         = 50              ;
MaxTsdr_6M         = 100             ;
MaxTsdr_12M        = 200             ;
;
Min_Slave_Intervall = 1              ; 100usec
;
;-----
Set_Slave_Add_supp = 0                ; Not Supported
Freeze_Mode_supp   = 0                ; Not Supported
Sync_Mode_supp     = 0                ; Not Supported
Fail_Safe          = 0                ; Not Supported
;
Modular_Station    = 1                ; Modular station
Max_Module         = 1                ; Max Module
;
Max_Input_Len      = 24               ; Maximum of input bytes
Max_Output_Len     = 24               ; Maximum of output bytes
Max_Data_Len       = 48               ; Maximum of data bytes
;
Max_Diag_Data_Len = 6                ; Maximum diagnostic length
;
;-----
Module = "DI DO 8byte/Remort 8word" 0xB7,0xF7
EndModule
;
;=====

```

MEMO

Revision record

Manual version	Issue date	Description
Ver. 1.06	Dec. 2007	Addition of SRCP30 to supporting controller version. Clerical error corrections, etc.
Ver. 2.00	Oct. 2009	Addition of I/O assignment function. Addition of customize function for END output timing in execution of dedicated I/O command. Clerical error corrections, etc.
Ver. 2.01	Jun. 2011	The description regarding "Warranty" was changed.

User's Manual

YAMAHA
Single-axis/Dual-axis
Robot Controllers

SRCD/SRCP
ERCX/SRCX/DRCX

PROFIBUS
network board

Jun. 2011

Ver. 2.01

This manual is based on Ver. 2.01 of Japanese manual.

© YAMAHA MOTOR CO., LTD.

IM Operations

All rights reserved. No part of this publication may be reproduced in any form without the permission of YAMAHA MOTOR CO., LTD. Information furnished by YAMAHA in this manual is believed to be reliable. However, no responsibility is assumed for possible inaccuracies or omissions. If you find any part unclear in this manual, please contact YAMAHA or YAMAHA sales representatives.