

HXYx 2 axes / ZL

● XZ type ● Cable carrier ● Z-axis: clamped base / moving table type (200W)

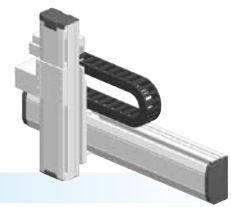

Ordering method

HXYx - C [] [] **ZL** [] []

Model	Cable	Combination	X-axis stroke	ZR-axis	Z-axis stroke	Cable
F1			25 to 125cm		25 to 55cm	3L: 3.5m 5L: 5m 10L: 10m

RCX320-2 [] **R** [] [] [] [] []

Controller / Number of controllable axes	Safety standard	Regenerative unit	Option A (OP.A)	Option B (OP.B)	Vision System	Absolute battery
--	-----------------	-------------------	-----------------	-----------------	---------------	------------------

Specify various controller setting items. RCX320 ▶ **P.660**

RCX222 [] **R** [] [] [] []

Controller	Usable for CE	Regenerative unit	I/O selection 1	I/O selection 2
------------	---------------	-------------------	-----------------	-----------------

Specify various controller setting items. RCX222 ▶ **P.670**

Specification

	X-axis	Z-axis
Axis construction ^{Note 1}	F17	F14H-BK
AC servo motor output (W)	400	200
Repeatability ^{Note 2} (mm)	+/-0.01	+/-0.01
Drive system	Ball screw φ20	Ball screw φ15
Ball screw lead ^{Note 3} (Deceleration ratio) (mm)	20	10
Maximum speed ^{Note 4} (mm/sec)	1200	600
Moving range (mm)	250 to 1250	250 to 550
Robot cable length (m)	Standard: 3.5 Option: 5,10	

Note 1. Use caution that the flange machining (installation holes, tap holes) differs from single-axis robots.
 Note 2. Positioning repeatability in one direction.
 Note 3. Leads not listed in the catalog are also available. Contact us for details.
 Note 4. When the X-axis stroke is longer than 850mm, resonance of the ball screw may occur depending on the operation conditions (critical speed). In this case, reduce the speed setting on the program by referring to the maximum speeds shown in the table below.

Maximum payload (kg)

X stroke (mm)	Z stroke (mm)
250 to 1250	250 to 550
	20

Controller

Controller	Operation method
RCX320-R	Programming / I/O point trace / Remote command / Operation using RS-232C communication
RCX222-R	

HXYx 2 axes / ZL (F1)

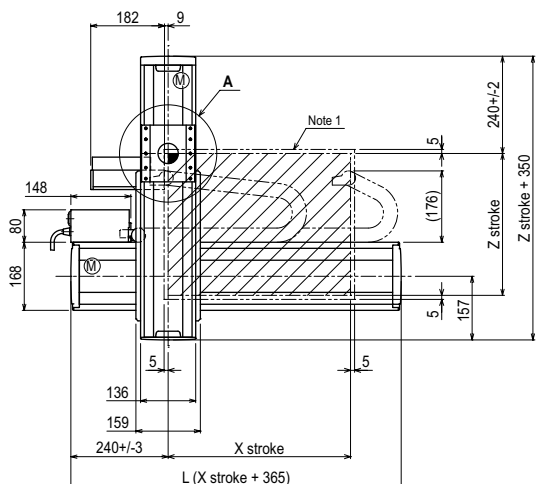
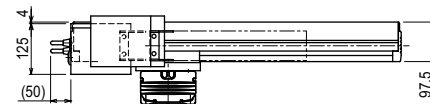
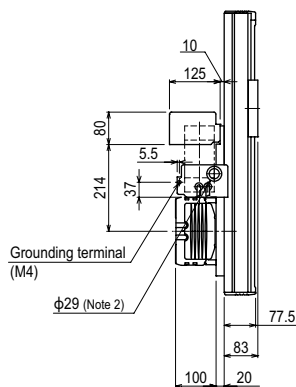
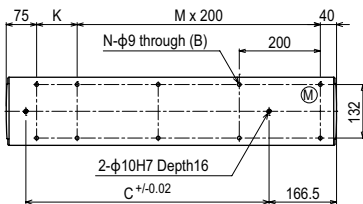
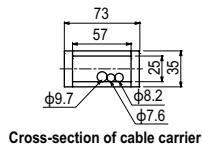
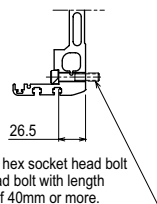
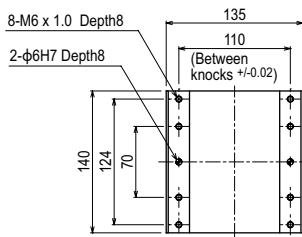

X stroke	250	350	450	550	650	750	850	950	1050	1150	1250
L	615	715	815	915	1015	1115	1215	1315	1415	1515	1615
K	100	200	100	200	100	200	100	200	100	200	100
C	240	420	600	600	780	780	960	960	1140	1140	1320
M	2	2	3	3	4	4	5	5	6	6	7
N	8	8	10	10	12	12	14	14	16	16	18
Z stroke	250	350	450	550							
Maximum speed for each stroke (mm/sec) ^{Note 3}	X-axis		1200				960	840	720	600	480
Speed setting			-				80%	70%	60%	50%	40%

Note 1. The moving range when returning to origin and the stop position when stopping by the mechanical stopper.
 Note 2. User cable extraction port.

Note 3. When the X-axis stroke is longer than 850mm, resonance of the ball screw may occur depending on the operation conditions (critical speed). In this case, reduce the speed setting on the program by referring to the maximum speeds shown in the table at the left.