

YHX controller is introduced on another page.

Features page P.32

Specifications page P.610

CONTROLLERS

An optimal controller can be selected from various command input formats.

As servo parameters and deceleration patterns suitable for robots are pre-registered, robots can be operated quickly without complex settings.



High performance controllers supporting YAMAHA robots

		TRANSERVO	FLIP-X		PHASER	
		Stepping motor	[T4L/T5L] Small type servomotor (24 V • 30 W)	General-purpose servomotor (30 to 600 W)	Linear motor	
1 axis	<ul style="list-style-type: none"> I/O point trace Remote command Online command 	 TS-S2 TS-SH		 TS-X	 TS-P	TS-S2/ TS-SH/ TS-X/TS-P P.626
	<ul style="list-style-type: none"> Pulse train 	 TS-SD	 ERCD	 RDV-X	 RDV-P	TS-SD P.636 RDV-X/ RDV-P P.640 ERCD P.646
	<ul style="list-style-type: none"> Program (YAMAHA SRC language) I/O point trace Remote command Online command 			 SR1-X	 SR1-P	SR1-X/ SR1-P P.652
2 axis	<ul style="list-style-type: none"> Program (YAMAHA BASIC language) ^{Note 1} I/O command Remote command Online command 			 RCX222 RCX221	 RCX320	RCX320 P.660 RCX221/ RCX222 P.670
	<ul style="list-style-type: none"> Program (YAMAHA BASIC language) ^{Note 1} Remote command Online command 			 RCX340		RCX340 P.678

Five or more axes can also be supported

up to 16 axes

RCX320 RCX340

YC-Link/E

Up to four RCX320, RCX340 controllers (up to 16 controllable axes) can be connected.

The RCX340 controller and RCX320 controller can be connected.

All programs and settings are managed using the master.

Connectable using LAN cable. YC-Link/E

Controllers without program settings

Note 1. The RCX320, RCX340 uses YAMAHA BASIC2 language.

P : Robot positioner **D** : Robot driver **C** : Robot controller

POINT 1

Selectable from various control methods

Program input

A variety of operation settings, calculations, and conditional branching is possible

The single-axis robot controllers use the YAMAHA SRC language ^{Note} which is simple yet contains all required functions, such as I/O outputs and conditional branching, etc. The multi-axis controller RCX series uses the YAMAHA BASIC language capable of more sophisticated programming and includes all types of arithmetic operations, flexible variable settings, and various conditional branching, etc. Both are easy to use robot language conforming to the BASIC. These languages support various needs from simple operations to expert user's sophisticated work.

Note. The 2-axis controller DRCX also uses YAMAHA SRC language.

Single-axis robot controller	YAMAHA SRC language <Example>	MOVA 1, 100	Moves to point number 1 at 100 %-speed.
		DO 1, 1	Turns on general-purpose output number 1.
		WAIT 2, 1	Waits until general-purpose input number 2 turns on.
Multi-axis robot controller	YAMAHA BASIC language <Example>	IF DO(10)=1 THEN *END	Jumps to *END if general-purpose input number 10 turns on. Otherwise, moves to the next line.
		MOVE P, P2, STOPON DI(1) =1	Moves to point number 2. Stops when general-purpose input number 1 turns on during movement.
		WAIT ARM	Waits until the robot arm operation ends.
		P3=WHERE	Writes the current position into point number 3.
		*END:	Defines the label named "END".
	HOLD	Pauses the program.	

I/O point trace

Program-less means easy

The host unit specifies a point number in binary format and the robot moves to the specified point when the start signal is input. The controller can operate only by teaching the point data without programs.

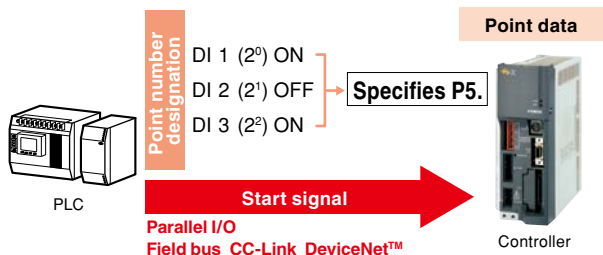

Remote command

Ideal for unified data management

The word function of the CC-Link or DeviceNet™ is used to issue various commands or data to the robot. The expandability of the word function from simple operation instructions to point data writing is fully utilized to freely use the robot controller functions from the host unit.

Note. This function is enabled when selecting an option network board.

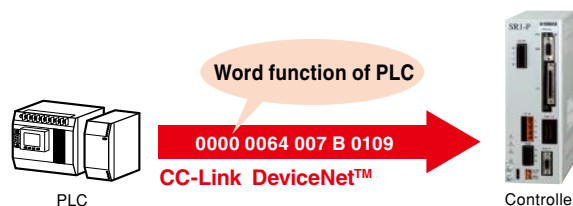

Pulse train

Acceleration/deceleration curves can be created freely

The robot is controlled using pulse trains sent from the positioning unit. The controller does not need to have programs or point data. This pulse train is convenient when the control is centralized to the host unit.

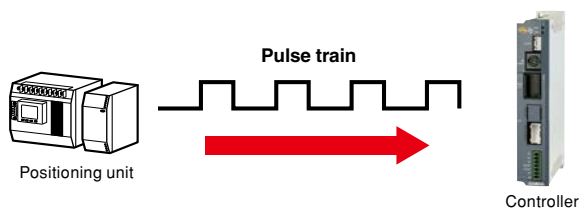

Online command

Execute everything from a PC

The PC can issue various commands or data to the controller or receive the data or status through the RS-232C or Ethernet ^{Note}. All executable operations from the teaching pendant can be executed from the PC.

Note. Ethernet is enabled when selecting an option network board. (For the RCX340, Ethernet is provided as standard function.)



Easy optimal setup

Complicated parameter settings are unnecessary

Robot controllers are specially designed for YAMAHA robots. Optimal values for servo parameters required for robot operation, such as gain are already registered beforehand. **Start operating immediately without any need for complicated settings or tuning, even if you don't have knowledge or experience about control.**

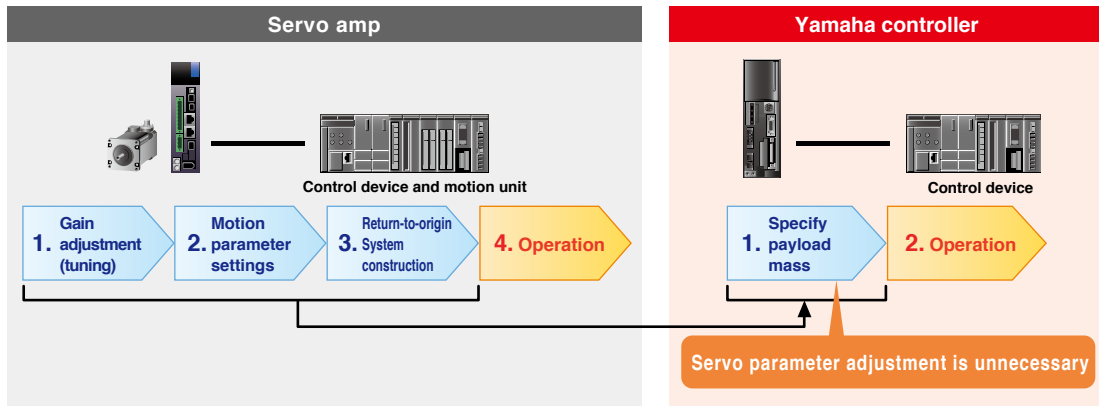

Easy acceleration/deceleration settings

The acceleration/deceleration is an important factor that affects the service life of the machine. **If too high acceleration is set, this may cause the service life of the machine to shorten. If the acceleration is too low, the motor power cannot be used effectively, causing the fact time to lower.** The acceleration/deceleration setting of YAMAHA robot controller is determined finely by load weight. Setting only payload parameters will automatically set optimal acceleration/deceleration by taking the service life of the machine and motor capability into consideration. Detailed robot knowledge from YAMAHA is what makes this possible. (Note: For the pulse train input, the customer may need to set the acceleration/deceleration.)

Concept of speed and acceleration

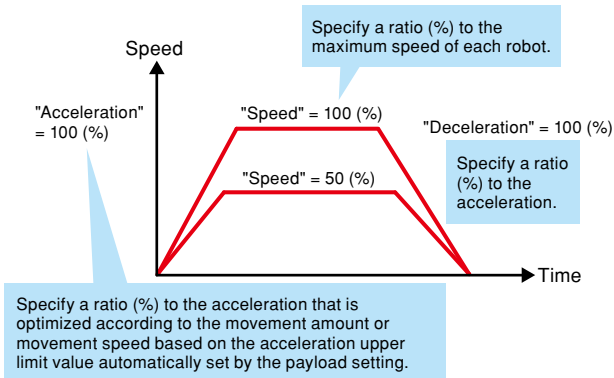

Acceleration calculation algorithm

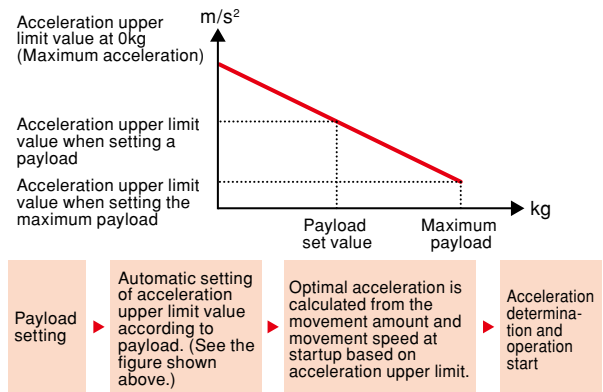

Zone control (= Optimal acceleration/deceleration automatic setting) function

The SCARA robot also incorporates a zone control function that always operates the robot at its maximum performance level by considering changes in inertia due to the arm posture. Therefore, the robot does not exceed the tolerance value of the motor peak torque or speed reducer allowable peak torque only by entering the initial payload to bring out the full power of the motor and keep the high acceleration/deceleration.

For X-axis of YK500XG

The torque in the arm folded state is 5 or more times different from that in the arm extended state.

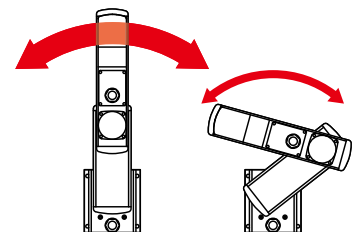

This may greatly affect the service life, vibration during operation, and controllability.

If the motor torque exceeds the peak value

→ **This may adversely affect the controllability and mechanical vibration, etc.**

If the torque exceeds the tolerable peak torque value of the speed reducer

→ **This may cause early breakage or shorten the service life extremely.**

POINT 3

Multi-function and expandability

■ Multi-axis controllers support up to 30,000 points (RCX2 series supports up to 10,000 points) while single-axis controllers support up to 1,000 points. Up to 100 programs can be created on each controller.

■ Various field networks, CC-Link, DeviceNet™, PROFIBUS, and EtherNet/IP™ are supported.

Note. Some models do not support all networks.

■ The TS series, RD series, SR1 series, and RCX series use a dual-power supply system with separate control power supply and power supply.

■ As the controllers conform to the CE marking that is safety standards in EU (Europe), they can be used safely even overseas.

The TS series (except for TS-S), SR1 series, and RCX series conform to up to safety category 4.

For details about functions of each controller, refer to controller details pages from P.605.

Name	Type	Number of points	Number of programs	Applicable network							Compliance with CE
				CC-Link	DeviceNet™	Ethernet	EtherNet/IP™	PROFIBUS	PROFINET	EtherCAT	
TS-S2/TS-SH	1 axis robot positioner	255	-	○	○	-	○	-	○	-	○
TS-X/TS-P		255	-	○	○	-	○	-	○	-	○
TS-SD	1 axis robot driver	-	-	-	-	-	-	-	-	-	○
RDV-X/RDV-P		-	-	-	-	-	-	-	-	-	○
ERCD	1 axis robot controller	1,000	100	-	-	-	-	-	-	-	-
SR1-X/SR1-P		1,000	100	○	○	○	-	○	-	-	○
RCX320	1 to 2 axes controller	30,000	100	○	○	○	○	○	○	○	○
RCX221/RCX222	1 to 2 axes controller	10,000	100	○	○	-	-	○	-	-	○
RCX340	1 to 4 axes controller	30,000	100	○	○	○	○	○	○	○	○

RDV-X/RDV-P

P.640

FLIP-X

PHASER

[Robot driver]



Operation method	Pulse train
Input power	Main power Single-phase/3-phase AC 200 V to 230 V Control power Single-phase AC 200 V to 230 V
Origin search method	Incremental

Dedicated pulse train control

The dedicated pulse train control has achieved a compact body and a low price.

Position setting time reduced by 40%

The response frequency is enhanced about two times in comparison with former models. The position setting time of uniaxial robots is reduced by about 40%.^{Note 1}

Large cost reduction possible

It is easy to assemble them in automated machinery. You can save much labor in designing, parts selection, setting and more. A large cost reduction is possible.

Contributing to saving space for the whole control board

The compact design has reduced the width up to a maximum of 38% in comparison with former models. In addition, the improvement of radiation efficiency makes it possible to arrange the devices with less space in between. Multiple units can be installed side by side in a neat arrangement.

Easy replacement

The parameter settings and fastening-hole pitches are the same as those of former models. It is easy to replace the software and the hardware as well.

Command input: Line driver (2 Mpps)

Command output: ABZ-phase output (with a divider function)

Real-time operation status monitoring

You can have analog outputs for speed, amperage, and more information to know the operation status in real time. RDV-Manager, the dedicated support software, is also available for a graphical view of the status.

Main power: Single and three phases supported (200V)

The full-specification operation is available with a single-phase power supply.

Note 1. With a 400W servomotor, 20mm ball screw lead, and portability of 40kg.

TS-S2/TS-SH/TS-SD POINT

Usable for all TRANSERVO series models

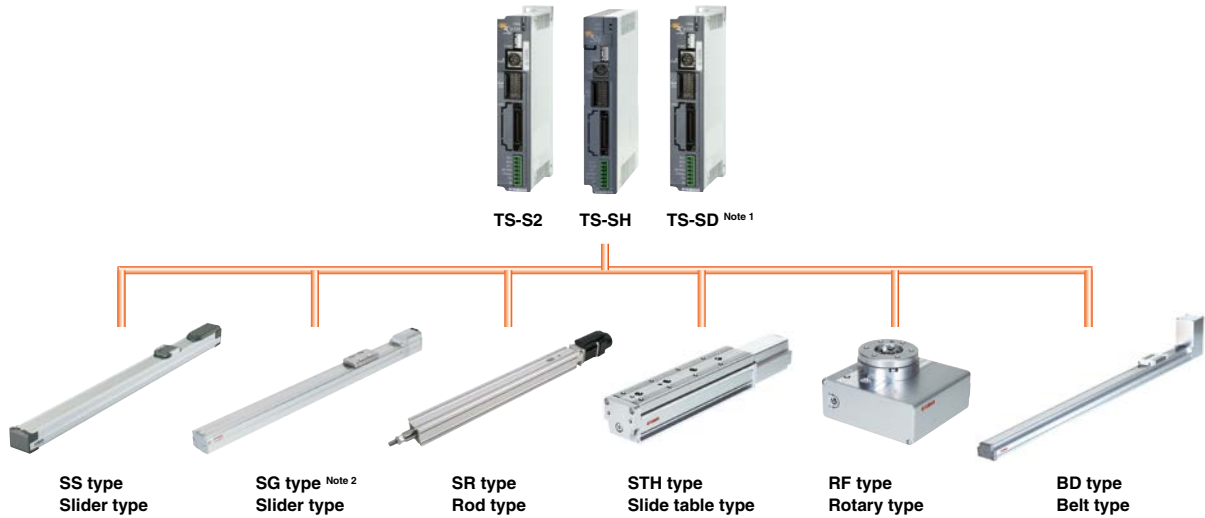

Note 1. The STH type vertical specifications and RF type sensor specifications do not support the TS-SD.
 Note 2. SG07 is only applicable to TS-SH.

TS-SD

P.636

TRANSERVO

[Robot driver]



Operation method	Pulse train	
Input power	Main power	DC 24 V +/- 10 %
	Control power	DC 24 V +/- 10 %
Origin search method	Incremental	

■ Pulse train input driver dedicated to "TRANSERVO"

A robot driver dedicated to the pulse train input for "TRANSERVO".

■ Torque decrease in high-speed area is suppressed

As a vector control method is used, the torque decrease in high-speed area is small and high-speed operation even with high payload can be performed. This greatly contributes to shortening of the tact time.

■ Excellent silence

High-pitched operation sounds unique to the stepping motor are suppressed to achieve silent operation sounds similar to the AC servo.

■ Easy operation with support software TS-Manager

In the same manner as the robot positioner TS series, the operation can be performed with the TS-Manager (Ver.1.3.0 or later) having various convenient functions, such as robot parameter setting, backup, and real-time trace (The handy terminal "HT1" cannot use this TS Manager).

■ Applicable to a wide variety of pulse train command inputs

This robot driver can be made applicable to the open collector method or line driver method using the parameter setting and signal wiring. In the open collector method, a wide voltage range from 5 V to 24 V is supported. So, the robot driver can be matched to the specifications of the host unit to be used.

■ TS-Manager: Real-time trace function

The current position, speed, load factor, current value, and voltage value, etc. can be traced at real-time. Additionally, as trigger conditions are set, the data when the conditions are satisfied can be automatically acquired. Furthermore, as a range is specified from the monitor results, the maximum value, minimum value, and average value can be calculated. So, this is useful for the analysis if a trouble occurs.

Real-time traceable items (up to four items)		
• Voltage type	• Command position	• Current position
• Command speed	• Current speed	• Internal temperature
• Command current value	• Current current value	• Motor load factor
• Input/output I/O state	• Input pulse count ^{Note 1}	• Movement pulse count ^{Note 1}
• Word input/output state ^{Note 2}	Note. 1: TS-SD only Note. 2: TS controller only	

■ Daisy chain function

As multiple TS series controllers and drivers are connected in a daisy chain, the data of a desired unit can be edited from the personal computer (up to 16 units).

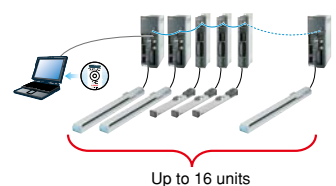

TS-S2/TS-SH P.626 **TRANSERVO**

TS-X/TS-P P.626 **FLIP-X** **PHASER**

[Robot positioner]



Operation method	Point trace Remote command Online command
Number of points	255 points
Input power	Main power DC 24 V +/- 10 % Control power DC 24 V +/- 10 %
Origin search method	TS-S2 Incremental TS-SH Absolute Incremental



Operation method	Point trace Remote command Online command
Number of points	255 points
Input power	AC 100 V / AC 200 V
Origin search method	TS-X Absolute Incremental TS-P Incremental Semi-absolute

Design that allows a clean installation

Unified installation sizes

Height and installation pitch are unified throughout the series. Units can be installed neatly within the control board.

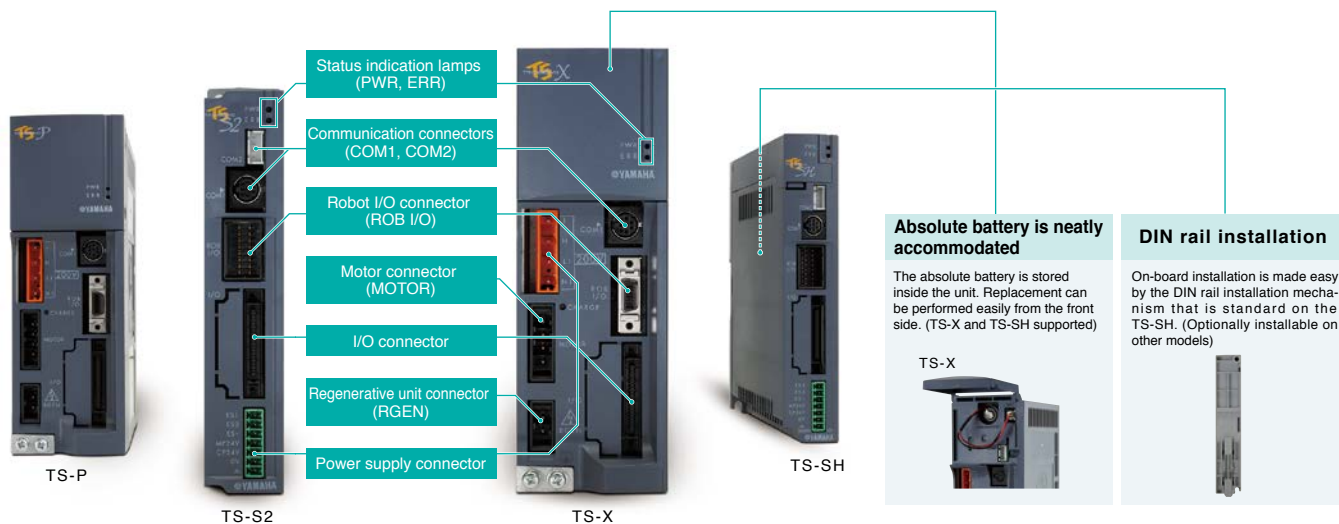

Selectable I/O interfaces

Two RS-232C ports provided

● **Connect support tools**

Intuitive operation supports controller design and maintenance.

● **Daisy-chaining**

Two ports can be used to daisy-chain up to 16 units.

● **Communication commands**

Easily understood ASCII text strings can be used to perform robot operations.



Selectable 100V/200V

- The TS-X/P let you select AC100/200V as the power input. (The 20A model is 200V only.)
- The TS-S2/SH is DC24V input.

A variety of I/O interfaces

In addition to NPN and PNP, you can choose CC-Link, DeviceNet™, EtherNet/IP™, and PROFINET field networks.



● **Positioner interface**

Functionality has been condensed into an I/O interface with 16 inputs and 16 outputs. In addition to easy positioning, this also includes functionality that enhances interoperability with the control device.

● **Remote commands**

Numerical data can be directly manipulated by using the four-word input and four-word output areas. You can add new direct positioning commands to further unify the data at the control device.

● **Gateway function**

New types of connection are provided to reduce network costs. (CC-Link, EtherNet/IP™, and PROFINET are supported.)

Positional interface

"Positioner function" for easy positioning

You can easily perform positioning operations by specifying the number of a point that is registered in the data, and entering a start command.

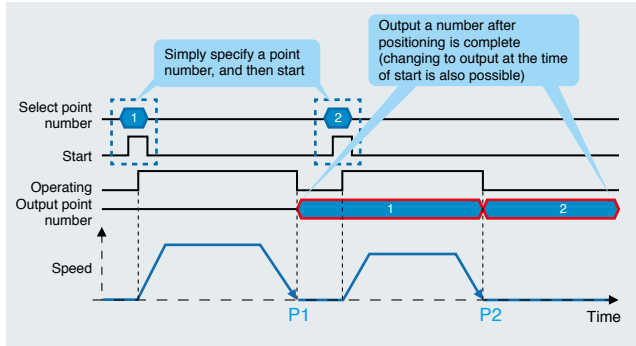

Number	Operation type	Position (mm)	Speed (%)	Acceleration (%)	Deceleration (%)	Branch	Timer (ms)
P1	ABS	100.00	100	100	100	0	0
P2	ABS	200.00	80	100	100	0	0

A variety of output functions

The TS controller provides a variety of status outputs that are linked with positioning operations. By selecting and using an output appropriate for the scene, this can contribute to cost-saving measures such as making the steps of the control device's program more efficient or by reducing the peripheral equipment.

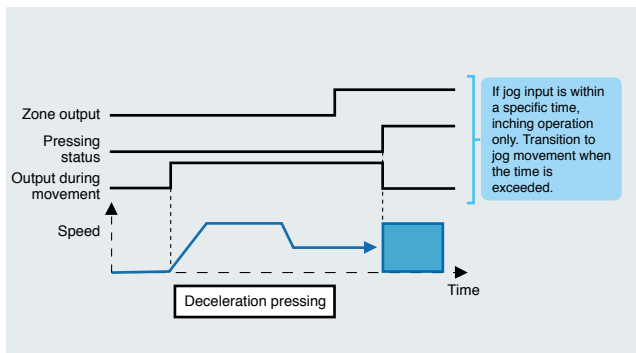

List of outputs	
• Zone output	Output ON when between the two specified points
• Near position output	Output ON when entering the specified region from the goal position
• In movement output	Output ON when above the specified speed
• Pressing status	Output ON when specified pressing strength is reached

Also provided are return-to-origin completed status, manual mode status, warning output, and alarm number output, etc.

Consecutive operation, linked operation

By specifying a branch destination, it is possible to execute positioning operations consecutively. Additionally, by specifying linked operation, operation with the branch destination can be executed while changing the speed without positioning stops; this allows control programming to be simplified and takt to be shortened.

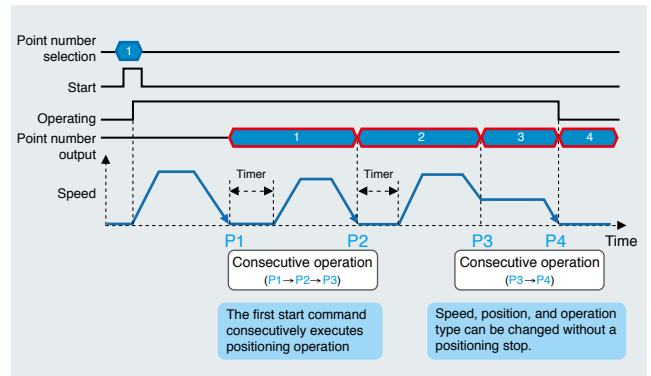

Number	Operation type	Position (mm)	Speed (%)	Acceleration (%)	Deceleration (%)	Branch	Timer (ms)
P1	ABS	100.00	100	100	100	2	500
P2	ABS	200.00	80	100	100	3	800
P3	ABS linked	300.00	100	100	100	4	0
P4	ABS	350.00	30	100	100	0	0

Jog and point teaching functions are provided as standard

Jog movement and point teaching functions are provided as standard for input signals. By linking these with buttons of a touch panel etc., a simple teaching system can be constructed.

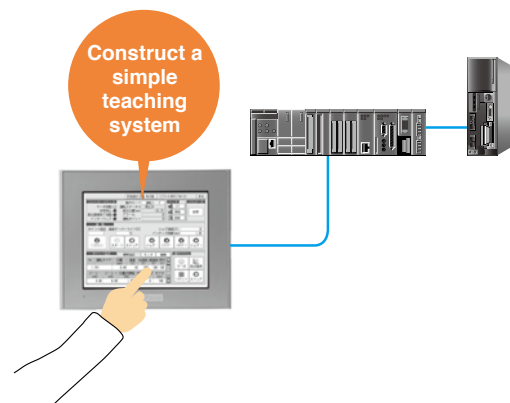

TS-S2/TS-SH/TS-X/TS-P

Remote commands

Ideal for unifying data management

Remote commands are functions by which the control device can directly handle data such as points and parameters using the word area of the field network.

Numerical data can be operated directly by using the word area. This promotes unification of data management.

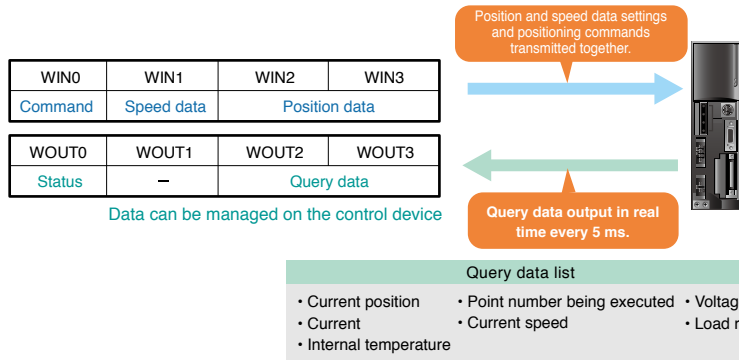

New function Direct positioning commands that directly specify position and speed data

As remote commands, "direct positioning commands" are provided, allowing the position and speed data to be specified directly and then positioning operations to be performed. In addition to unifying the positioning data on the control device, this allows it to be done with a single command, simplifying programming of the control device.

Consecutive queries for realtime update of various status information

Normally, remote commands only update data when responding, but if a consecutive query is issued, the data continues to be updated at a fixed interval until permission is given to stop. This is useful in various cases such as when it is desirable to obtain positioning data during operation for interoperation with peripheral devices, or to obtain current values in order to monitor the status of a robot.

Parallel processing of "positioner interface" and "remote commands"

Since positioner interface and remote commands operate independently of each other, parallel processing is possible.

- < Usage examples >
- Obtain the current position during positioning operation
 - Obtain the current position during jog movement
 - Change the target position during linked operation

		Positioner interface		Remote command
		Positioning operation	Jog movement	Positioning operation
Remote commands	Data write	○	○	-
	Data read	○	○	-
	Consecutive query	○	○	○

○ : Parallel processing possible

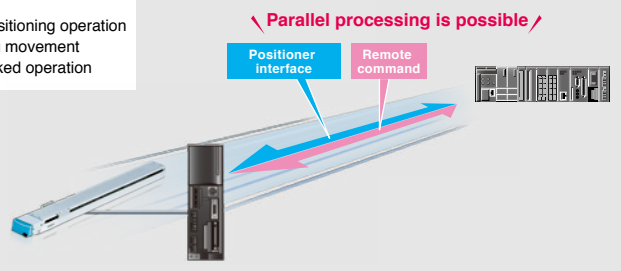

"Gateway function" — a new way to connect

New function

Decrease network cost

One controller equipped with a field network board can provide unified management of up to four I/O interfaces via a daisy-chain connection. This allows network cost to be decreased while enabling the same type of I/O control as when one board is installed for each unit. (CC-Link and EtherNet/IP™ are supported)

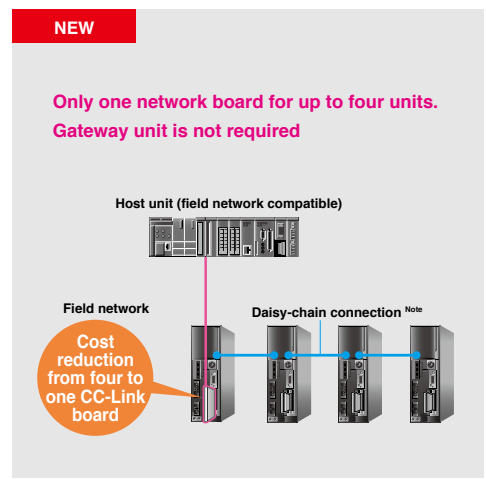
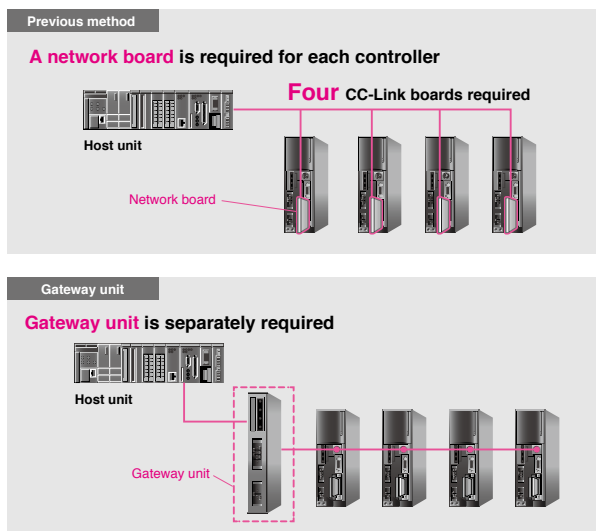

Note. Daisy chain connection cable is required.

Daisy chain connection

No need to connect or disconnect cables during operation (up to 16 units)

From a single PC, handy terminal, or touch-panel display, it is possible to specify point data and parameters, perform operations, and monitor the status for up to 16 axes on daisy-chained controllers. For everything from design to maintenance, a connection to only the first controller is sufficient; any desired controller can be accessed simply by switching the station number, without having to connect or disconnect cables.

Communication commands

An easily handled command protocol using ASCII text strings supports a wide range of needs from data editing to operation and status monitoring. By daisy-chaining multiple devices, simple multi-axis control can be performed.

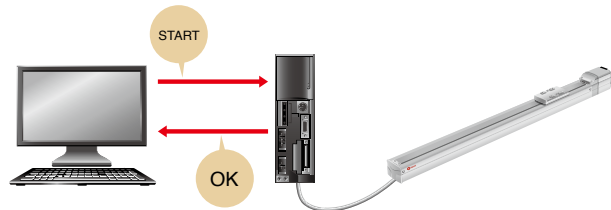
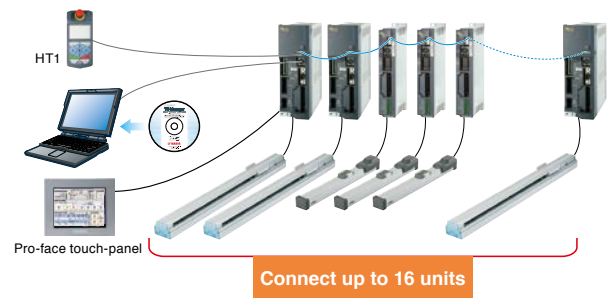

"KEYENCE PROTOCOL STUDIO Lite" serial communication settings software

By loading a TS settings file into PROTOCOL STUDIO Lite, communication settings and main communication commands can be registered automatically. Ladder-less data editing and daisy-chaining can be easily accomplished.

Contact for questions regarding PROTOCOL STUDIO Lite
Keyence Corporation, www.keyence.co.jp/red/kv01/

Daisy-chain connections (up to 16 axes)

Communication with the KV-L21V uses a Yamaha-made communication cable (D-sub type). By using daisy-chain connections, up to 16 axes can be managed together.



Automatic device assignment for each communication command

If the communication type is specified as cyclic, the desired information to be obtained is automatically stored in data memory.



Touch operator interface "Pro-Face" GP4000 Series

Connecting GP4000 Series made by Pro-face to Robot Positioner, TS-S2, TS-SH, TS-X, TS-P enables you to use a lot of functions as well as basic operations on Touch Operator Interface.

Free download of the program file from the Pro-face home page
<http://www.proface.com>

Can easily check a state and change settings.

- Check the status (the current position, speed etc)
- Basic operations such as Jog operation, inching operation, return to origin, error reset etc.
- Set, edit, or back up point data and parameters
- Check triggered alarms and detailed descriptions of alarm history

Supports 3 languages

- Supports Japanese, English, and Chinese (simplified, traditional)

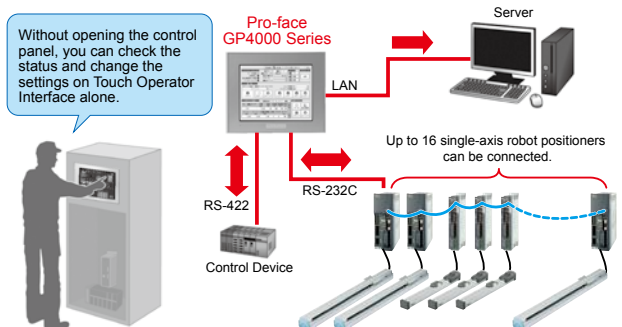

SR1-X/SR1-P

P.652

FLIP-X

PHASER

[Single-axis robot controller]



SR1-X SR1-P

Operation method	Program
	Point trace Remote command Online command
Number of points	1000 points
Input power	Control power
	Main power
Origin search method	SR1-X Absolute, Incremental
	SR1-P Incremental, Semi-absolute

Various command methods

An optimal method can be selected from various command methods, such as program, point trace, remote command, and online command. The program uses the YAMAHA SRC language that is similar to the BASIC. Various operations, such as I/O output and conditional branching, etc. can be executed using simple operations.

Applicable to complete absolute position system

The SR1-X is applicable to complete absolute position system. No return-to-origin is needed. (The backup period is one year in the non-energizing state.)

I/O assignment function

As the I/O assignment is changed, the point trace operation, point teaching, and trace operation by specifying coordinate values can be selected in addition to the normal program operation. Since the JOG movement through the I/O is possible in the point teaching mode, the point teaching can be performed from the host unit without the HPB.

Current position output function

The position data is output as feedback pulse or binary data. This allows the host unit to understand the current robot position at real-time. Furthermore, functions, zone output or point zone output to output near point number are incorporated.

Torque limiting

As this function limits the maximum torque command value at desired timing, it is effective in operations such as pushing and workpiece gripping operations. Furthermore, in addition to the torque limiting by the parameter data value, the torque limiting by the analog input voltage can be performed.

ERCD

P.646

T4L/T5L

[Single-axis robot controller]



ERCD

Operation method	Program
	Point trace Online command Pulse train
Number of points	1000 points
Input power	DC 24 V +/-10% maximum
Origin search method	Incremental

Four command formats

A desired command format can be selected from four command formats, program operation using various commands, point trace operation only by instructing a point number, online command, and pulse train input.

Compact design

Compact box size of W 44 × H 142 × D 117mm is achieved with the functions improved. The installation space can be reduced greatly.

Various input/output functions

As a feedback pulse output function is provided, the host control unit can easily manage the current position. Additionally, as the movement point number can be output in binary format during point trace, the operation can be checked easily. As a teaching function using the I/O is added, the flexibility and usability of the system configuration are further improved.

This output is enabled in the program or point trace operation and the number of outputs can be changed to a desired level using the division setting.

Various monitor functions

The controller status can be checked using the input/output status monitor, duty monitor, and LED status display.

Error history and alarm history

The error or alarm history that occurred in the past can be displayed and checked on the HPB or personal computer screen.

Robot number management

As the controller is initialized by the robot number of the robot to be controlled, parameters suitable for each robot model are automatically registered and no complicated servo adjustment is needed.

Torque limiting control

The torque limiting control can be performed using the program command. The axis can be stopped with the torque applied. This torque limiting control can be used for continuous positioning of workpieces with different sizes, press-fitting work, and workpiece holding operation.

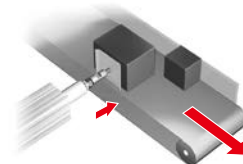

Zone output function

The general-purpose output on/off setting between desired points can be performed using the parameter setting. The positive logic/negative logic setting can be made and the axis position can be easily judged by an external unit. Up to four patterns can be set.

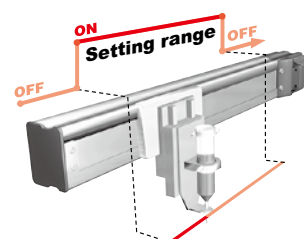

SR1-X/SR1-P/ERCD Various functions

Position data output function

Zone output

Outputs whether or not the robot position is within the specified range.

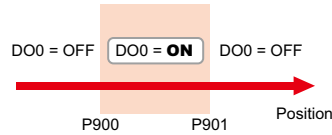

It is possible to reverse the output logic.

Point zone output

Outputs the point number near the robot position in binary format.

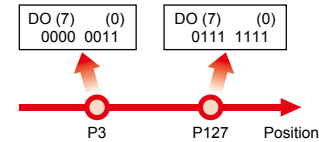

It is also possible to limit to only the moving point.

Binary output

Outputs the current robot position in 16-bit binary format. (This function is available only in the SR1.)

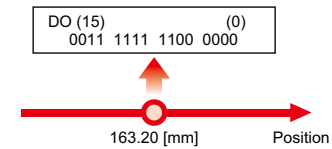

It is possible to adjust the unit of the output position data to be output using parameters.

Feedback pulse output

Outputs the current position counter value of the robot through the A/B-phase line driver.

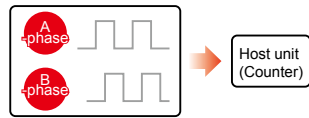

It is possible to perform the monitoring by host unit at real-time. A frequency division function is built-in.

Point teaching

The JOG movement of the robot and the point reaching can be performed from the host unit.

Concept

- The robot is moved to the teaching position using the JOG+/JOG- command.
- The current position is registered into the point number specified by the PSET input.



Torque limiting function

As the torque limiting is performed during operation, the operation, such as pushing and workpiece gripping can be performed.

Concept

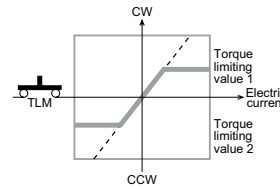

Features

SR1

- Host unit manages the limiting time using the TLM input.
- Limiting status is understood using the torque limiting status output (TLON).
- Torque limit value is changed (up to 4 patterns) using the input.
- Torque can be limited using the program command.
- Torque can be limited using the analog input (0 to +10 V / 12 bit).

ERCD

- Torque can be limited using the T program command.

Movement data change function

The movement speed or target position can be changed during movement. (This function is available only in the SR1.)

Concept

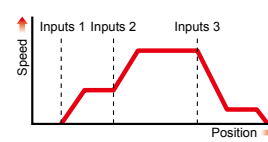

Features

- Host unit manages the limiting time using the movement command input.
- Movement command is ABS-PT (absolute movement command) or ABS-BN (binary specified movement command).
- Change speed can be specified in a range of 1 to 100 % (up to 4 patterns).
- Changing is disabled in the deceleration zone.

YAMAHA SRC language convenient functions

Multi-task function

This function can execute multi tasks, such as robot peripheral units in parallel at the same time. Up to four tasks can be executed. With the multi-task function combined with JMPP command, the I/O signals can be output when the robot passes through the specified point during movement.

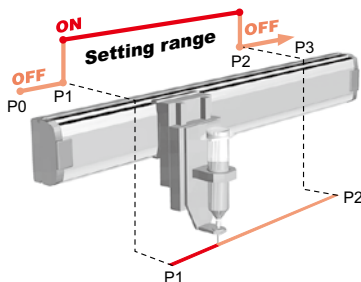

Conditional stop function during movement

The arm can be decelerated and stopped using I/O conditions of the MOVF command while it is moving. This function is useful when searching for the target position with the sensor.

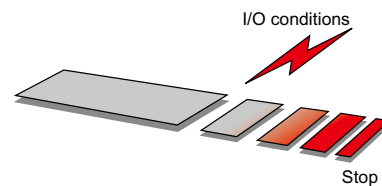

RCX2 series

RCX221/222

P670

[Multi-axis robot controller]



Operation method		Program, Remote command Online command
Number of points		10000 points
Input power	Control power	Single phase 200 to 230V AC +/-10% maximum
	Main power	Single phase 200 to 230V AC +/-10% maximum
Origin search method		Incremental, Semi-absolute

RCX221



Operation method		Program, Remote command Online command
Number of points		10000 points
Input power	Control power	Single phase 200 to 230V AC +/-10% maximum
	Main power	Single phase 200 to 230V AC +/-10% maximum
Origin search method		Incremental, Semi-absolute

RCX222

Applicable to all YAMAHA robot models

The RCX series is applicable to all YAMAHA robot models, such as PHASER, FLIP-X, and XY-X, etc. As the single-axis robot (FLIP-X/ PHASER) can be combined with the Cartesian robot freely, various applications can be supported (except for some compact single-axis robots).

Complete absolute position system

The RCX uses complete absolute specifications that need no return-to-origin when the power turns on. The completely same system can be applicable to the incremental specifications. (When the PHASER series uses the magnetic scale, it is applicable to the semi-absolute or incremental specifications.)

Extension of absolute data backup time

As the backup circuit is improved to the energy saving, the absolute position data retention period in the non-energizing state is greatly extended. The maximum one month of the conventional model is extended to approximately one year. The current position information is monitored during long vacations, equipment storage, or even during transportation, and no return-to-origin is needed when energized again. This allows quick production start.

Area check output function

This function can output the I/O signals when the robot enters a set area during operation. Up to eight check areas can be set.

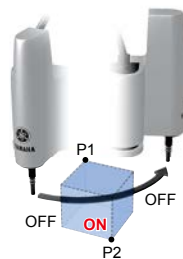

Applicable to dual-drive

A dual-drive function is incorporated that controls two axes synchronously. This function is effective for heavy workpiece transfer or Y-axis long stroke of the Cartesian robot. The function can perform the operation using the high-speed and high acceleration/ deceleration of YAMAHA robots.

Note. The dual-drive is supported as a custom order. For detail, please consult YAMAHA.

Example of dual-drive



Double-carrier anti-collision function

When using the double-carrier, collisions between both carriers can be prevented by the control in the controller. Collision preventions by the zone judgments or external sensors are no longer needed to make the double-carrier easier to use.

3D linear/circular interpolation control

2D and 3D linear and circular interpolation controls are possible. This ensures the smooth and highly accurate operations suitable for the sealing work. (The 3D interpolation is not available in the RCX221/222.)

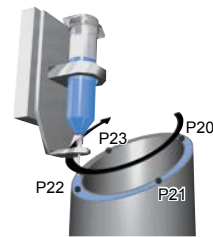

Palletizing function

This function can easily define up to 20 kinds of pallets only by entering four corner positions on the pallet as the teaching points. When entering the teaching point in the height direction, even three-dimensional pallets are supported.

When specifying the defined pallet number and executing the movement command, the palletizing work is then performed. Various operations, one point → pellet, pallet → one point, and pallet → pallet, can be performed using the programs.

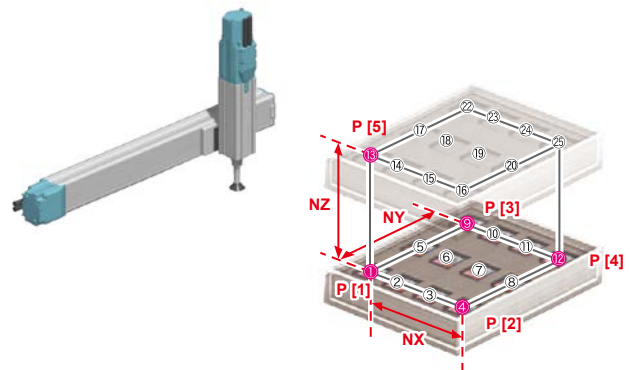

Hand definition

This function operates the robot based on coordinates of the offset tool tip when the tool is attached to the tip of the robot axis in the offset state. Particularly, this function is effective during tool rotation of SCARA robots or robots including the rotation axis.

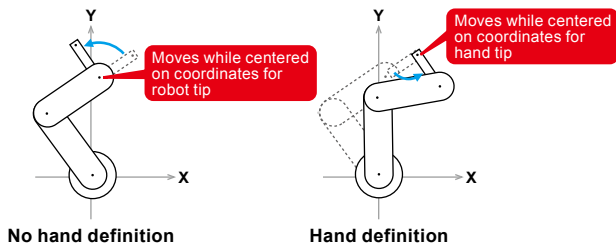

Shift coordinates

A deviation may occur in the coordinate system when re-installing or replacing the robot during maintenance work. In this case, the coordinate system can be corrected using the shift coordinate function. So, the point data can be used as it is. No re-teaching is needed.

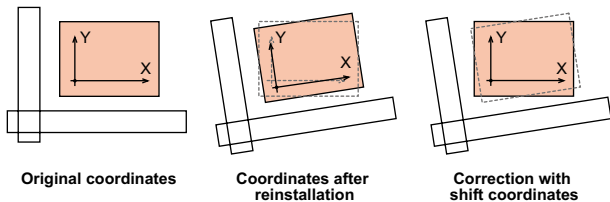

Passing point output control

The general-purpose output on/off can be controlled by specified points without stopping the axis operation during interpolation operation. The dispense can be turned on or off with the axis operated during sealing to allow smooth and stable dispensing.

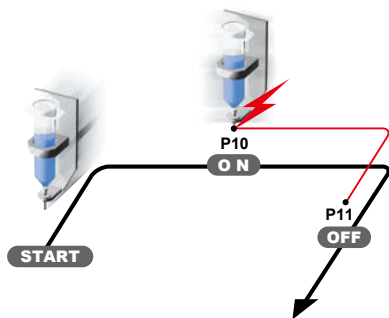

Torque limiting function

The motor torque can be limited during gripping or press-fitting.

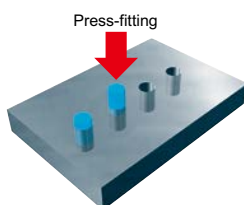

Multi-task function

This function can execute multi tasks (up to eight tasks), such as robot peripheral units in parallel at the same time. When there are multiple tasks, the task can be changed by means of the time sharing method and a priority can be put on the task. Additionally, the priority can also be changed while the task is running. The multi-task function simplifies the control configuration of the entire system to improve the operation efficiency.

Task scheduling

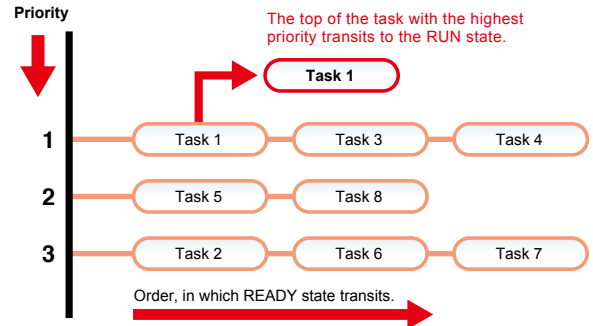

Sequence program

In addition to the normal task, a task to individually control the input/output (parallel, serial, memory, timer) can be executed. As the sequence program can be enabled even in the manual mode, this is effective to construct a safety system linked with peripheral units.

2-robot control

Two robots that are assigned to the main and sub robots can be simultaneously controlled using one controller. As this function is used together with the multi-task, advanced and smooth linking of two robots can be performed using one controller.

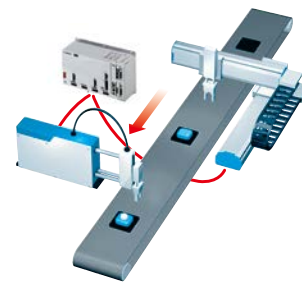

Powerful support software: VIP+ (plus)

This application software allows you to easily and visually operate the robot, create and edit programs, and teach points.

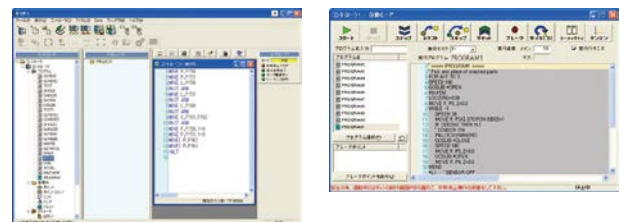

RCX3 series

RCX320

P.660

2 axes

RCX340

P.678

3 to 4 axes

[Multi-axis robot controller]



RCX320

Operation method	Program, Remote command Online command	
Number of points	30000 points	
Input power	Control power	Single phase 200 to 230V AC +/-10% maximum
	Main power	Single phase 200 to 230V AC +/-10% maximum
Origin search method	Absolute, Incremental Semi-absolute	



RCX340

Operation method	Program, Remote command Online command	
Number of points	30000 points	
Input power	Control power	Single phase 200 to 230V AC +/-10% maximum
	Main power	Single phase 200 to 230V AC +/-10% maximum
Origin search method	Absolute, Incremental Semi-absolute	

Advanced functionality allowing construction of high-level equipment

Multiple robots can be operated synchronously through the high-speed communication. Use of linking among controllers makes it possible to store programs into only one controller. Use of a newly developed algorithm achieves shortening of the positioning time and improvement of the tracking accuracy.

The control of multiple robots can be managed using one master controller

The RCX340 controller allows high-speed communication among the controllers. As the operation command can be sent to the controller of each slave from the master controller, the programs or points can be managed only using the host master controller. Additionally, as this controller supports multi tasks flexibly, data exchanging with the PLC can be simplified. Simultaneous start and simultaneous arrival of each robot can be controlled freely. Complicated and precision robot system using many axes can be constructed at a low cost.

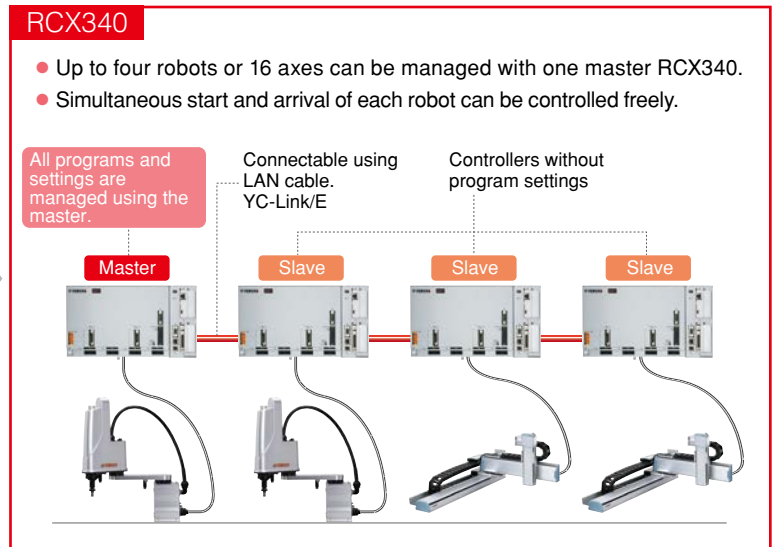
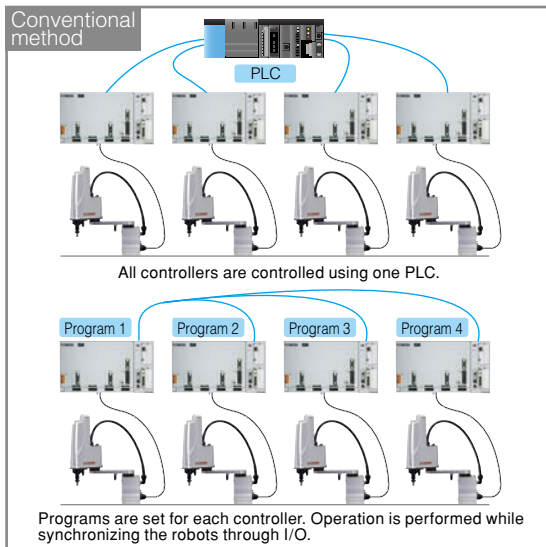

Arch motion can be specified more intuitively

As the arch motion route designation method is changed and the designation method is simplified, the arch motion can be specified more intuitively.

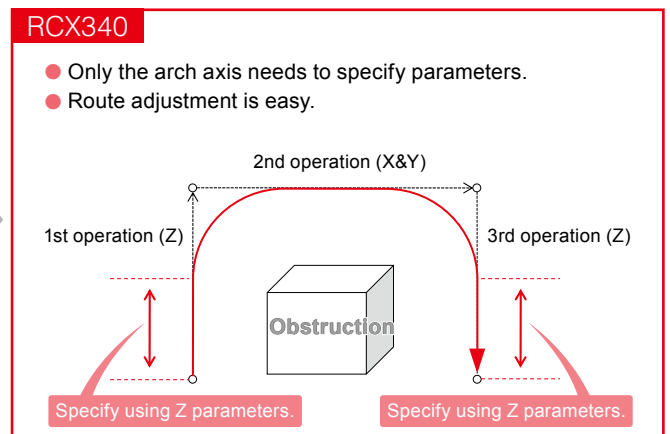
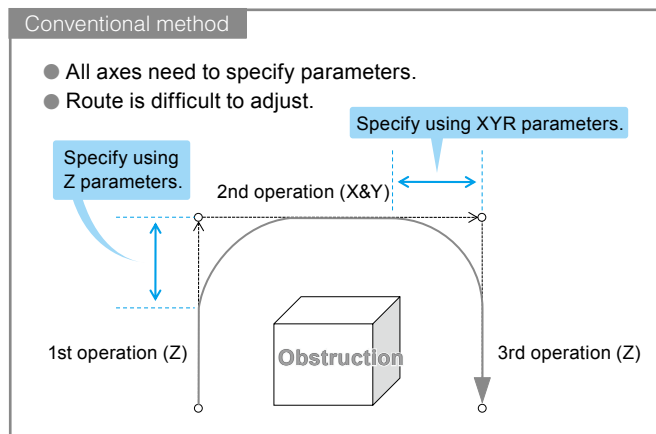

Smooth movement is achieved by greatly improving motion functions

As a new servo motion engine is incorporated, various operations can be merged. Use of a newly developed algorithm achieves shortening of the positioning time and improvement of the tracking accuracy.

Expansion of CONT option function

Different type operations, such as PTP, interpolation operation, and conveyor tracking, etc. are merged to improve the speed.

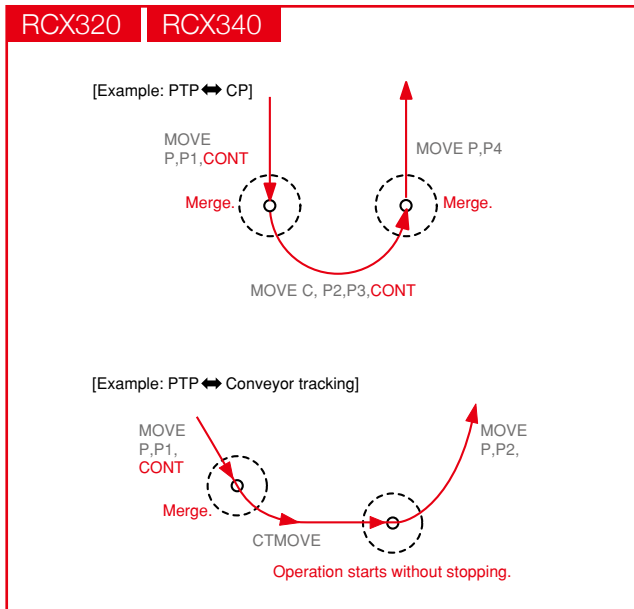

Improvement of operation speed ^{Note}

All operations can be merged as much as possible using the merge PTP. As even operations with different acceleration or deceleration time are merged at maximum level with priority put on the operation time, the movement time is shortened greatly.

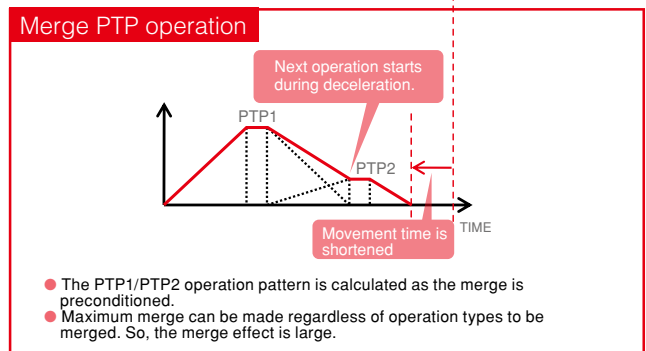
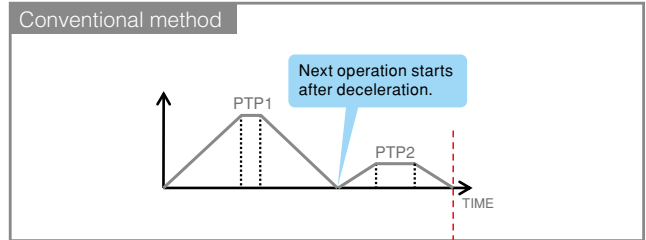

Proper use according to application ^{Note}

When performing the continuous operation, an optimal operation can be selected according the application, like traditional PATH is used for constant-speed operation, such as sealing and merge PTP is used for operation with priority put on the movement time.

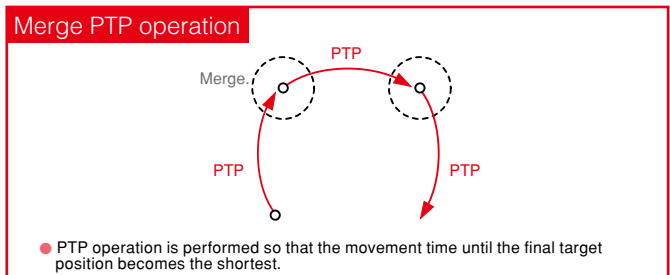
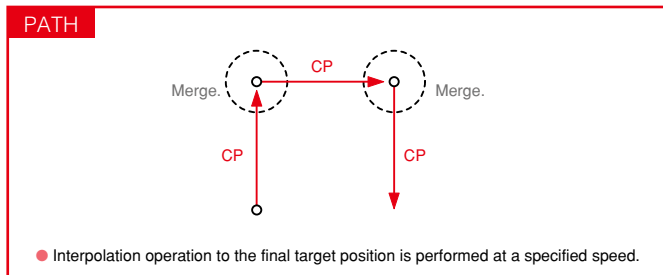

Note. It is necessary to upgrade the firmware to its latest version.

Improvement of tracking accuracy

Use of visualization with servo analyze function and high responsiveness with new servo function makes it possible to increase the follow-up ability and improve the tracking accuracy when compared to the conventional models.

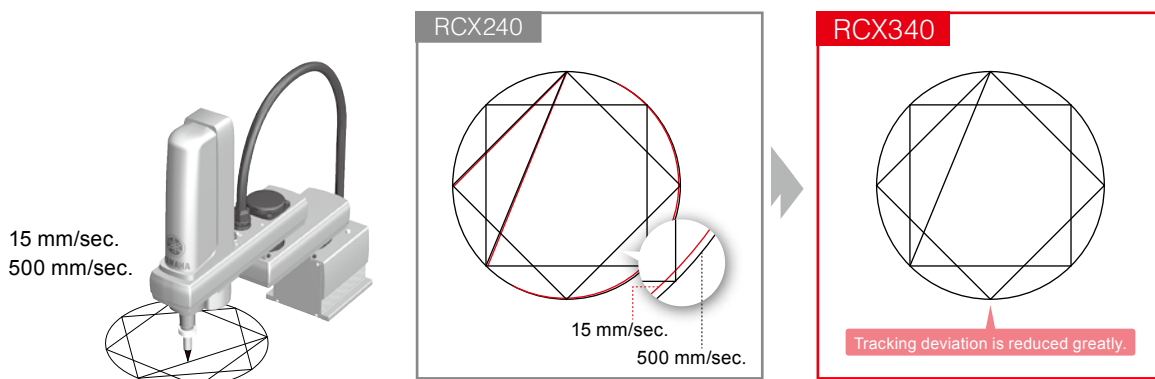

Improved basic performance

Functions, such as robot language, multi-task, sequence function, communication, and field bus are improved and made easier to use.

Motion optimization

The optimization of the motion to meet the operation pattern is further strengthened to bring out the robot performance at its maximum level. Higher quality robot operations, such as shortening of the operation time and suppression of vibrations during stopping are achieved.

Optimal acceleration/deceleration motion

Acceleration/deceleration motion is generated that can perform the high-speed operation while suppressing vibrations.

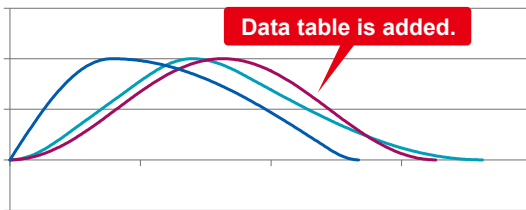

Compact design

The outside dimensions are approximately 355 mm (W) × 195 mm (H) × 130 mm (D). The volume ratio is reduced to approximately 85 % and the body size is made compact when compared to the conventional 4-axis controllers so as to make the installation inside the control panel easy.

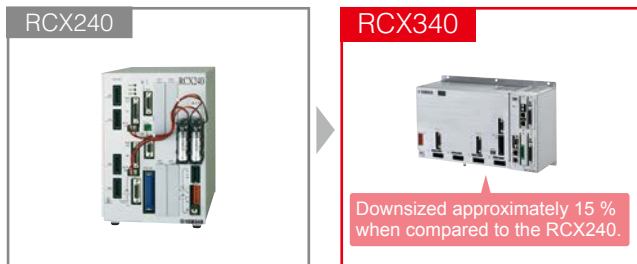

Improvement of cycle time

The speed-up of the YK-XG series is achieved.

Example: YK400XG

- Standard cycle time operation
0.49 sec → 0.45 sec

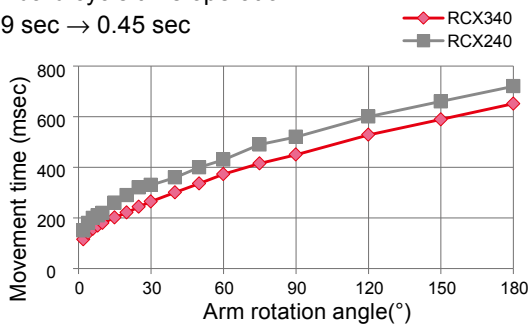

Built-in regenerative unit RCX340

As the regenerative unit (equivalent to RGU3) is built-in, no additional regenerative unit is needed when connecting to the existing robot.

User memory capacity increase

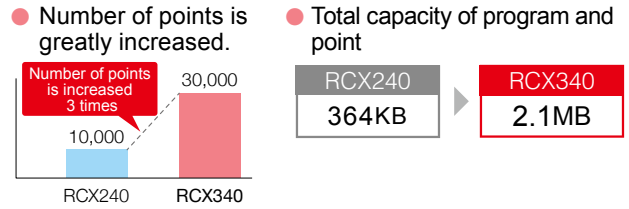

Economical solution for 6 axes ^{Note} robot setup.

Use of the inter-controller "YC-Link/E" system makes it possible to easily link the RCX340 controller with the RCX320 controller. The control of the 6-axis ^{Note} can be achieved at low cost.

Note. The vertical articulated robot YA series are outside the target.



PBX with USB port for backup

Simple and easy operation for adding function or editing work.

Storing backup data is a simple task.



Convenient LED Display for Error Status.

The operation status is displayed on the "7-segment LED display" located on the front panel of the controller.

If an error occurs, the relevant error message is displayed. The error status can visibly recognized without connecting the programming box.



▲ 7-segment LED display

PC Programming Software “RCX-Studio 2020”

New functions such as 3D simulator function and program template (program template automatic creation function) are added for ease of user operation.

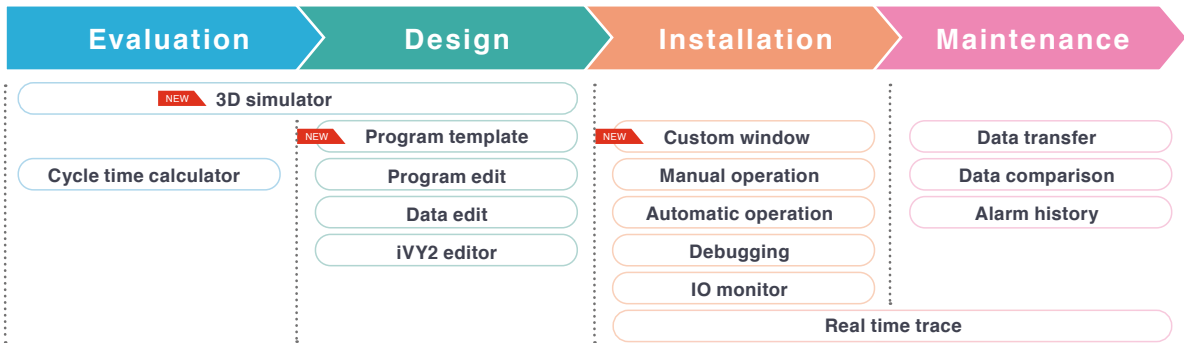

NEW 3D simulator

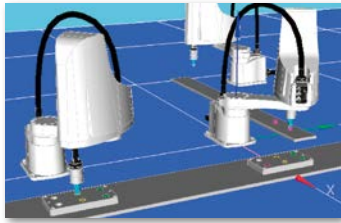

Layout can be verified beforehand without connecting robot.

Robots and peripheral devices are displayed in 3D, and the robot operation is simulated on PC.

- ▶ Robot layout, teaching, and debugging can be performed.
- ▶ Physical interference between the robot and peripheral device can be checked before operation is started.

NEW Program template (Program template automatic creation function)



Program creation time can be shortened greatly.

Program templates for 10 types of applications are incorporated. Just following the steps to perform the operation creates a program template automatically.

NEW Custom window creation

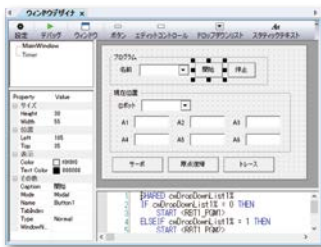

Operation screens suitable for the customer's equipment can be created.

GUIs for operators that are displayed on the panel computer can be created.

Other existing functions



All useful features from RCX-Studio Pro are succeeded to help supporting from startup to maintenance.

Cycle time calculator

Real time trace

Data comparison

Enhanced expandability

RS-232C and Ethernet ports are provided as standard equipment. A wide variety of high-speed and large capacity field networks, such as CC-Link, DeviceNet™, EtherNet/IP™, and EtherCAT are supported as options. Connections with general-purpose servo amplifier or other company's VISION are easy. So, the RCX320 and RCX340 is called "connectable controller".

Communication between controllers

YC-Link/E

Up to four RCX320 and RCX340 controllers (up to 16 controllable axes) can be connected.

- More flexible robot configuration
- Easy programming
- Centralized control of multiple robots
- Cost reduction

Applicable to various field buses/centralized control of robots through connections of up to four controllers

RS-232C and Ethernet ports are provided as standard equipment. Additionally, fulfilling field buses, such as CC-Link, EtherNet/IP™, DeviceNet™, PROFIBUS, PROFINET ^{Note 1}, and EtherCAT can be supported to connect and control a wide variety of devices. For 5 or more axes, use of YC-Link/E makes it possible to connect up to four RCX340 controllers so as to perform the centralized control of multiple robots.

Additionally, when using YC-Link/E ^{Note 2}, multiple robots can be handled as if they are operated using one controller. This ensures very easy robot programming and management.

Therefore, this robot controller contributes to reduction of unseen costs, such as labor cost necessary for the setup work.

Note 1. Supports PROFINET Ver. 2.2

Note 2. When ordering YC-Link/E, please specify what robot is connected to what number controller.

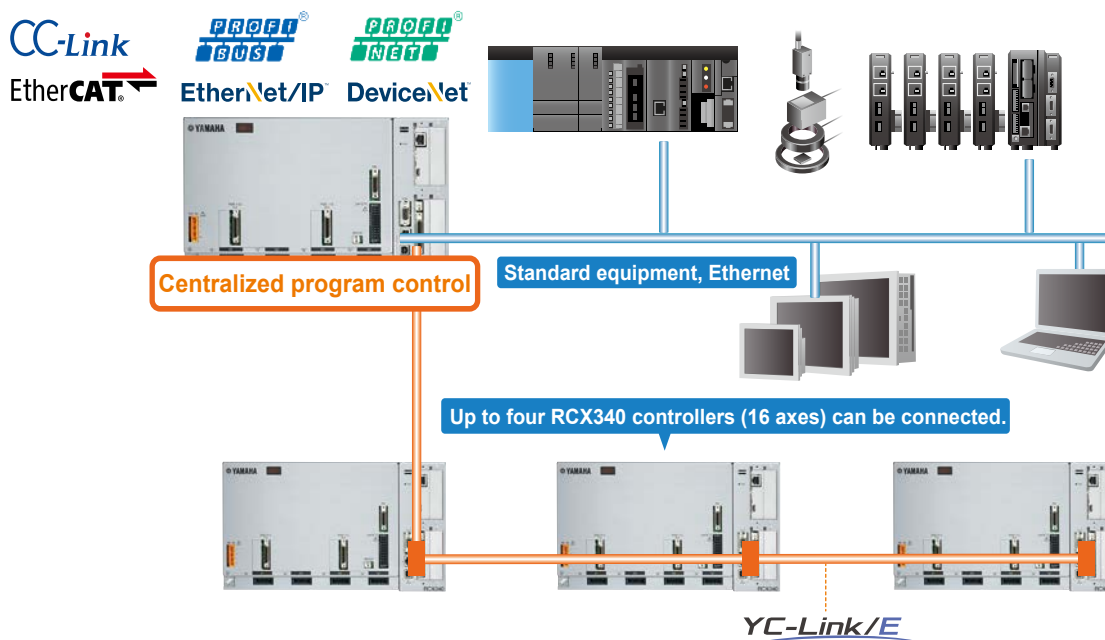

Applicable to electric gripper "YRG series"

The gripper can be controlled entirely by one RCX320 or RCX340 controller. Data exchanging with the host unit, such as PLC is not needed. The setup or startup is very easy.

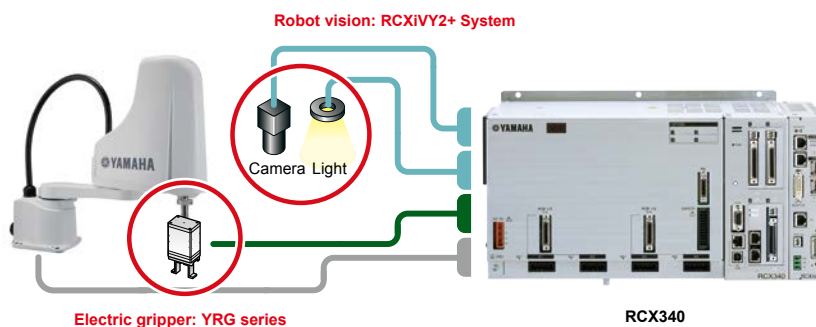

Real-Time output function for Preventive Maintenance.

Industrial Ethernet option Real-Time output function

When the industrial Ethernet option (EtherNet/IP, EtherCAT, or Profinet) is selected, the information necessary for the predictive maintenance such as error status, current position, current value, motor load factor, operation hours, and others can be output in real-time to contribute to achievement of the “non-stop production line”.

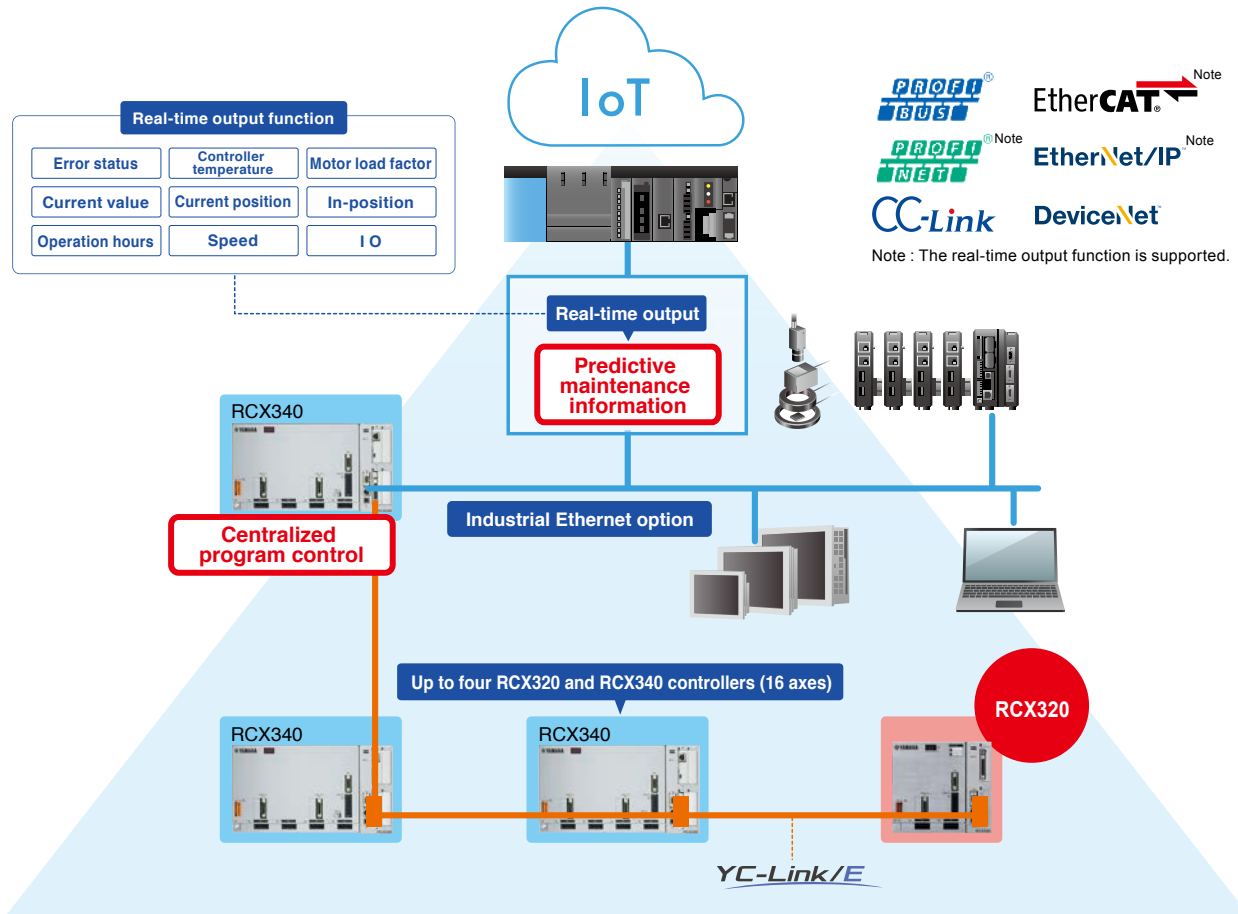

RCX340 are applicable to all single-axis, Cartesian, SCARA, and P&P robots ^{Note}

The 4-axis robot controller RCX340 are applicable to all robot models including single-axis, Cartesian, SCARA, and Pick & Place robots.

As the mixed control of the ball screw type FLIP-X series and linear motor type PHASER series can be performed, the robots can be combined freely according to the applications. Additionally, when preparing the robot controllers for the maintenance work of multiple robots, it is enough to prepare only one robot controller. This robot controller can be used for any model only by changing the setting.

Note. Except for 24 V specification models.

