

Integrated Robot Vision System with

Simplicity

Sophistication

Assurance

RCX 3 Series CONTROLLER YAMAHA ROBOT VISION

RCXiVY2+ SYSTEM

Yamaha's own unique solution for integrated robot vision



NEW Blob search function

For tracking irregular shape workpieces

- Easy Operation
- Wide range of applications
- Shorter startup time
- Comprehensive support of robot and vision by Yamaha

RCXiVY2+ SYSTEM

Camera 400,000 to 5 million pixels	Parts registration 254 types	Search time reduced by Approximately 50 % less	Maximum cable length 20 m	Monitoring Monitor output is provided
--	---	--	--	---

* Time depends on the workpiece.

Solutions RCXiVY2+ can provide:

Reducing teaching process time

Robot teaching work requires a lot of labor and time. The RCXiVY2+ system acts as "robot eye". The final fine positioning can be automated and greatly reduce the teaching time that was required for the conventional models.

Conveyor tracking

With a feedback from encoder of a conveyor RCXiVY2+ can do pick & place following conveyor or move.

Simplified positioning process

Reducing positioning process time in frequent lot change in small lot production. Cost in preparation, control, and switching positioning jigs can be reduced.

Yamaha's comprehensive support of Robot and Vision

Yamaha's integrated robot vision system. It means Yamaha supports both robot and vision system seamlessly. Have any questions and don't know if it is robot or vision related? Simply contact Yamaha representative. We have answers.

Random workpieces need to be handled.

With position detection function of RCXiVY2+, pick & place operation of random shaped parts from parts feeder or pallet can be simplified.

RCXiVY2+ features:

- Adjusting parts orientation on the fly
- Conveyor follower
- Searching randomly placed parts
- Top/bottom judgement
- OK/NG judgement



Simplicity

Setup is completed as little as eight minutes after power-on.
Auto-calibration makes setup easy.

Sophistication

With up to five million pixels, a variety of workpieces can be supported.
 Improve throughput to 100 CPM with conveyor tracking.

Assurance

Comprehensive support covers everything from camera image acquisition to the operation of the gripper and robot.
 With support that only the robot manufacturer can provide, you can relax.

Advanced RCX iVY2+ has been launched.



NEW Increased application features

- Picking of irregular shape workpieces
- Presence inspection
- Multiple piece count

NEW Enhanced performance

- CPU capability is increased to improve the search speed 8 to 45%.
- Number of pixels is increased.
- Frame rate is increased.

NEW Easy operation

- Supports template function of RCX-Studio 2020

Easy operation

New features for easy operation

NEW

High speed positioning of irregular shaped parts (foods or clothes)

Blob search function

Suitable for pick & place or detection of parts with wide tolerance in shape and size, or high speed counting.
Detection speed is 2 to 10 times faster than edge detection.



NEW

Detection time is shortened up to 45%.

By adopting a high-performance camera and improving the camera frame rate and CPU capability, detection time is reduced 8 to 45% while the resolution is improved.



Improved camera pixels

Improved camera frame rate

Improved CPU

Time
Up to 45% is shortened.

Comparison of search time

Conventional iVY2 (NEW) RCXiVY2+

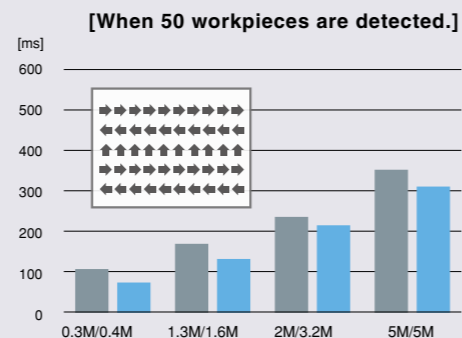
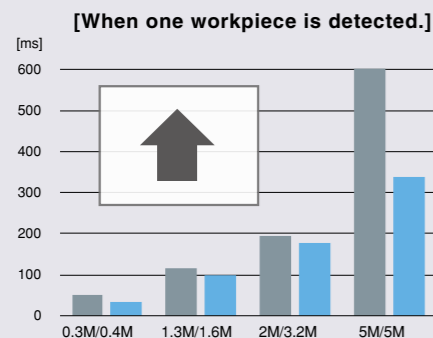

NEW

Suitable for parts detection and high volume parts count

Application examples

*Subject to application and conditions.

- Detection of electronics components on PC board
- Detection of accessories in package
- Counting of the number of bottles in pallet
- Detection of food labels
- Detection of screws and washers that secure parts
- Checking drilled holes
- Counting of electronics components

NEW

Overlap can be eliminated.

Overlapped workpieces are recognized and they can be excluded from the search target.

NEW

Detection with Speed

Comparing with edge search, blob search speed is 2 to 10 times faster.

Search speed

Up to 10 times faster

Comparison of edge search and blob search

* Only doughnut shape workpieces are detected.

Edge search

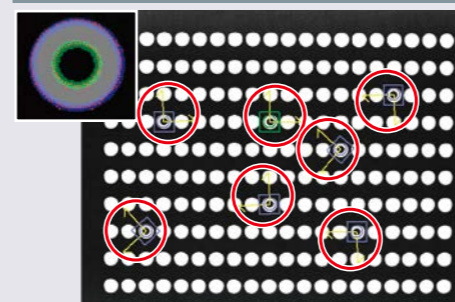

Blob search



[Comparison of search speed]

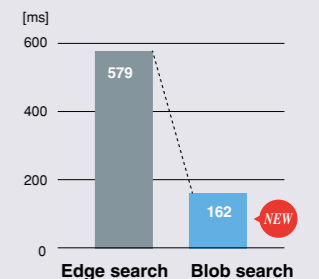

[Robot controller integrated type]

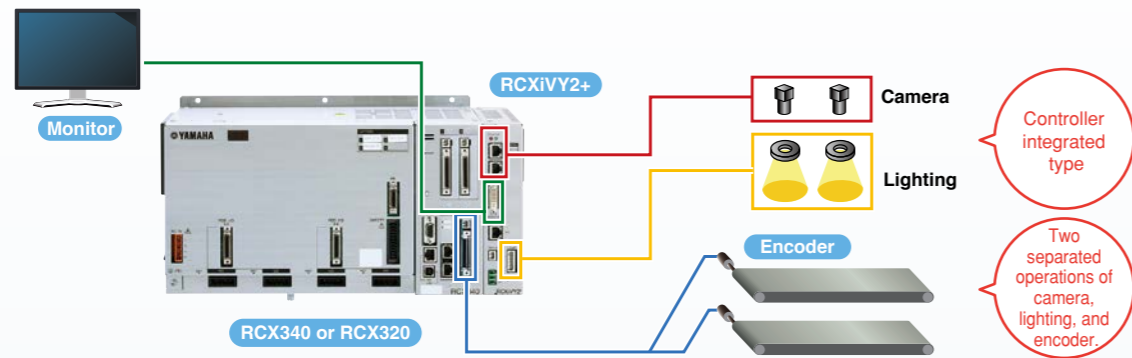

Typical Robot Vision setup

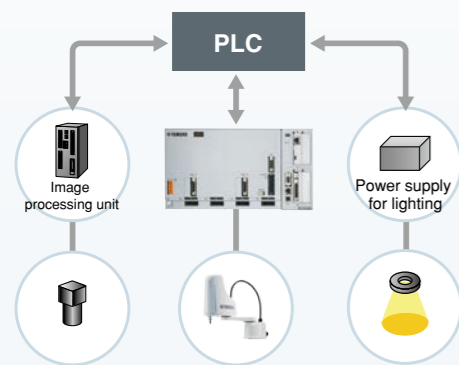

- 1 Time consuming robot coordinates alignment.
- 2 Need to calculate compensation for moving camera setup.
- 3 Operation deviation between the camera and robot due to communication time.
- 4 Adjustment of communication format is needed.

✗

- Handling not easy
- Installation and setup costs are high.
- Robot issue or vision issue? Who to call?

RCXiVY2+ system

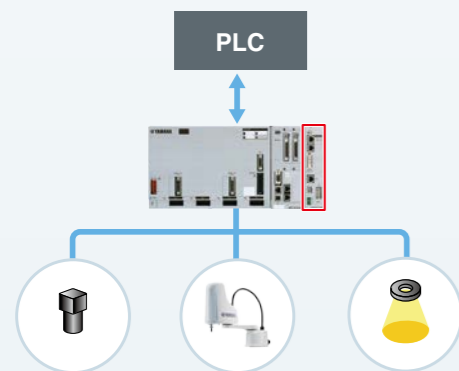

- 1 Simple calibration function is incorporated.
- 2 Coordinates are corrected automatically even when the camera moves.
- 3 High-speed connections through dedicated bus line.
- 4 Controller is incorporated to provide the central operation.
- 5 Applicable to all models of YAMAHA robot lineup.

○

- Easy to use
- Various applications are supported using easy operation.
- Cost reduction by reducing work steps.
- Robot and vision supported by Yamaha

Typical Robot Vision setup

```

MOVE P, P9
OFF LINE
SEND ( * ) TO CMU
SEND CMU TO P10
ON LINE
MOVE P, P10
    
```

Communication with image processing unit

RS-232C

Program of image processing unit

Program of host PLC

Camera and robot have separate programs

RCXiVY2+ system

```

MOVE P, P9
VSEARCH 1,2,0
P10=VGETPOS(0)
MOVE P, P10
    
```

Searches for workpiece.
Reads the point.
Moves to this point.

- POINT
- No communication time lag
 - Needs only few command lines.
 - Simple and easy to understand

Centralized control using only the robot program

[Examples of program commands]

VSEARCH ... Detect parts with designated camera

Camera and component type to be used for detection and the calibration data to be used can be switched with one command.

VSEARCH 1, 2, 1

- Camera: 1
- Component type number: 2
- Calibration data: 1

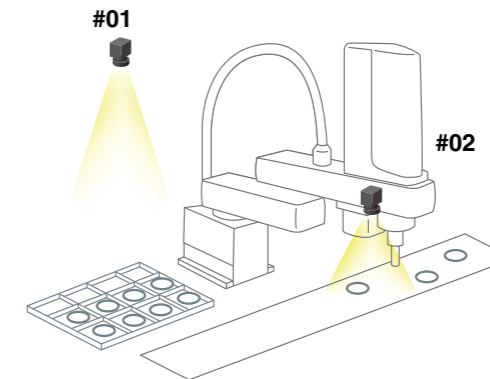
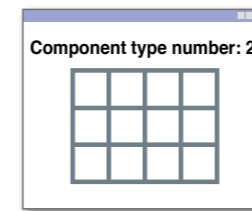

VSEARCH 2, 3, 2

- Camera: 2
- Component type number: 3
- Calibration data: 2

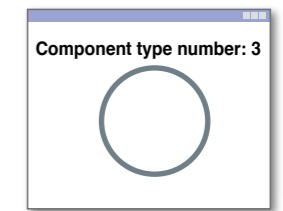

VGETPOS ... Acquires the coordinates of the detected workpieces.

The search results can be substituted into the point coordinates directly.

VSEARCH 1, 2, 1

... Detects the workpieces.

N = VGETCNT

... Substitutes the number of detected workpieces.

FOR J = 0 TO N-1

P[J] = VGETPOS (J)

... Acquires the workpiece coordinates.

NEXT J

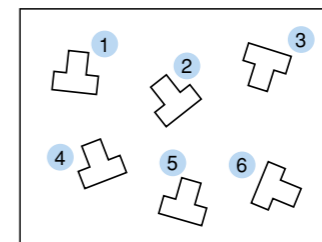

- VGETPOS (0) → Coordinates of 1
- VGETPOS (1) → Coordinates of 2
- VGETPOS (2) → Coordinates of 3
- VGETPOS (3) → Coordinates of 4
- VGETPOS (4) → Coordinates of 5
- VGETPOS (5) → Coordinates of 6

* The order to substitute into VGETPOS can be selected from the following.
1) Score order, 2) X coordinate, and 3) Y coordinate

LVOLUME ... Intensity of light is adjustable from 0 to 100% range

In detection mode intensity of light can be adjusted with one command.

Detection can be repeated with adjusted intensity.

With a robot program of RCXiVY2+, retry detection with adjusted light intensity can be easily performed

- Light 1 is set to 10%.
- Light 1 is set to 100%.

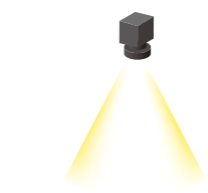

LVOLUME(1)=10

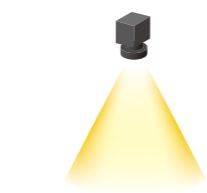

LVOLUME(1)=100

LVOLUME(1)=80

VSEARCH

↓ NG

LVOLUME(1)=100

VSEARCH

↓ NG

LVOLUME(1)=60

VSEARCH

↓ NG

Error process

OK

OK

OK

To next process

[3 easy steps for parts registration]

From image acquisition, registration takes just three steps.

Requires as little as
3 minutes

STEP. 1

Capture images.

Put the workpiece within the camera field-of-view and specify an image capturing range.



STEP. 2

Set the contour.

Contour is automatically extracted. Paint the necessary contour with a pen tool.

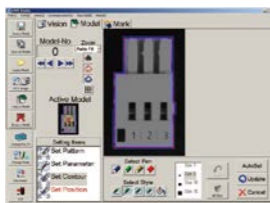

STEP. 3

Register the detection position.

Specify the detection position with the mouse. Desired positions can be set.

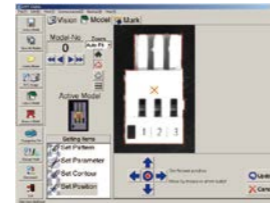

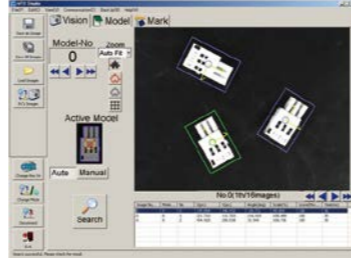

Search results

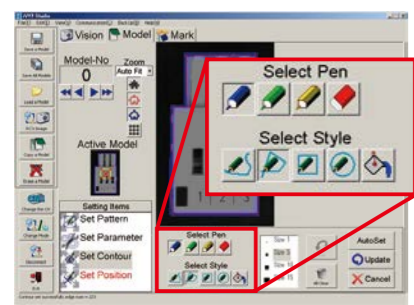

[Simple parts judgement process]



-  **Contour setting pen**
Paints the areas to be used from among the automatically detected edges.
-  **Priority area pen**
Paints the areas to be used as priority areas during search from among the edges.
-  **Reduction area pen**
Paints the areas where there should not be an edge during search.

[Usage example]



· Workpiece top or bottom judgement



· Simple OK or NG judgement





• Usage example of contour setting pen

When a workpiece with a partially different shape needs to be distinguished and recognized or when the top or bottom needs to be judged, the detection can be performed by painting the contours in different colors by combining the contour setting pen with the priority area pen and reduction area pen.

Detection results

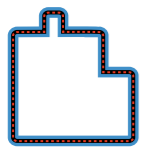
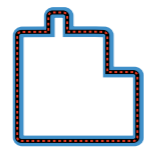
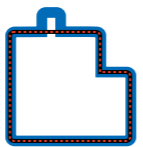
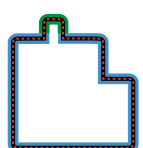
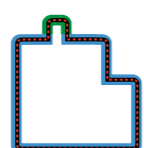
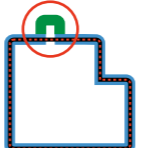
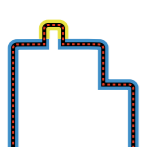
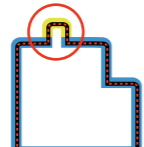
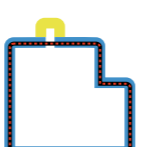
 <p>Blue : Normal contour setting All contours are handled equivalently.</p>	 <p style="text-align: center; color: blue;">OK</p>	 <p style="text-align: center; color: blue;">OK</p>	<p>The score may slightly vary depending on the presence status of the protrusion. However, both are detected.</p>
 <p>Green : Priority area setting In addition to the blue area search, areas painted in green are used as priority areas to perform the judgement.</p>	 <p style="text-align: center; color: blue;">OK</p>	 <p style="text-align: center; color: red;">NG</p>	<p>When no edge is detected in the area set as priority area, this is judged as NG and the workpiece is not detected.</p>
 <p>Yellow : Reduction area setting When there is an edge in the unnecessary area painted in yellow, the score is reduced.</p>	 <p style="text-align: center; color: red;">NG</p>	 <p style="text-align: center; color: blue;">OK</p>	<p>When an edge is detected in the area set as unnecessary area, the score is reduced and the workpiece is not detected.</p>

[Simple calibration]

Conventional equipment combining "image processing unit + robot" requires many steps in "calibration" that aligns the camera coordinates with the robot coordinates. With the RCXiVY2+ system, following the wizard to perform the operation will complete the calibration easily within a short time. In addition, even when the setting position deviates, the calibration is executed and restored immediately.

Requires as little as
5 minutes

STEP. 1

Register the desired fiducial mark



STEP. 2

Select the camera mounting method

Mounted on robot

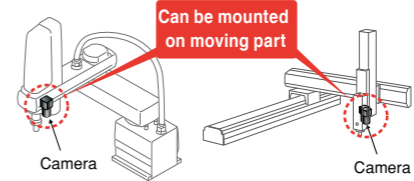

Can be mounted on moving part

Fixed upward

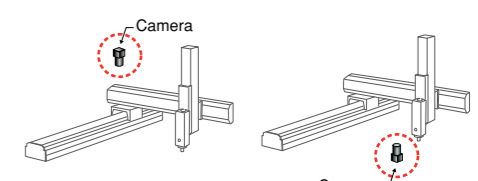

STEP. 3

Align fiducial mark position

If camera is movable, move the robot

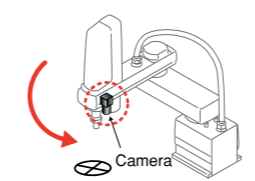

If camera is fixed, attach fiducial mark to robot, and move it

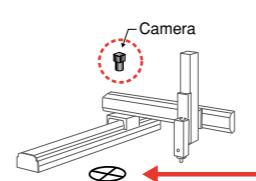

Execute auto-calibration

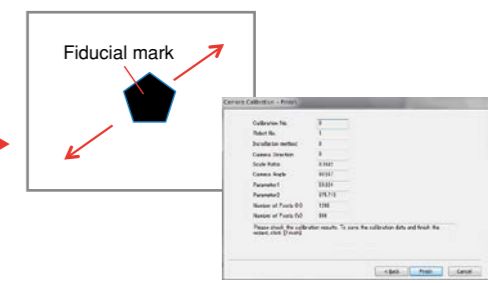

[Calibration is automated with the dedicated jig.]

By automating the calibration using the advanced calibration function, highly accurate calibration can be achieved easily without depending on the operator's skill. The hand data can also be created automatically and the time necessary for the calibration is reduced greatly. Since the dedicated jig is the standard part (option part), the jig does not need to be designed and manufactured and can be used immediately.

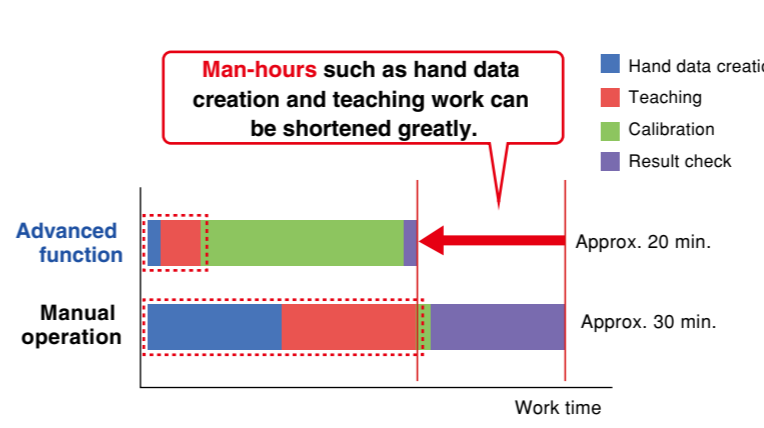

Man-hours such as hand data creation and teaching work can be shortened greatly.

Advanced function: Approx. 20 min.

Manual operation: Approx. 30 min.

Legend: Hand data creation (blue), Teaching (red), Calibration (green), Result check (purple).

Calibration jig

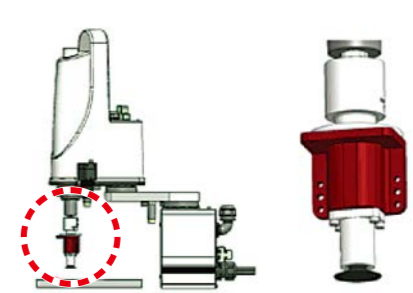

* This jig can be used only with the downward camera.

[Setup time reduced greatly]

When using third-party vision, a coordinate conversion program needs to be created in the robot controller since the robot coordinate data differs from the vision format.

In RCXiVY2+, vision system is incorporated in robot controller the robot coordinate data can be stored into the robot point data using single process. This ensures very simple operation. Additionally, the unified control of the camera control and light control can be performed using the robot program. Start-up process will be greatly simplified.

Comparison of setup time

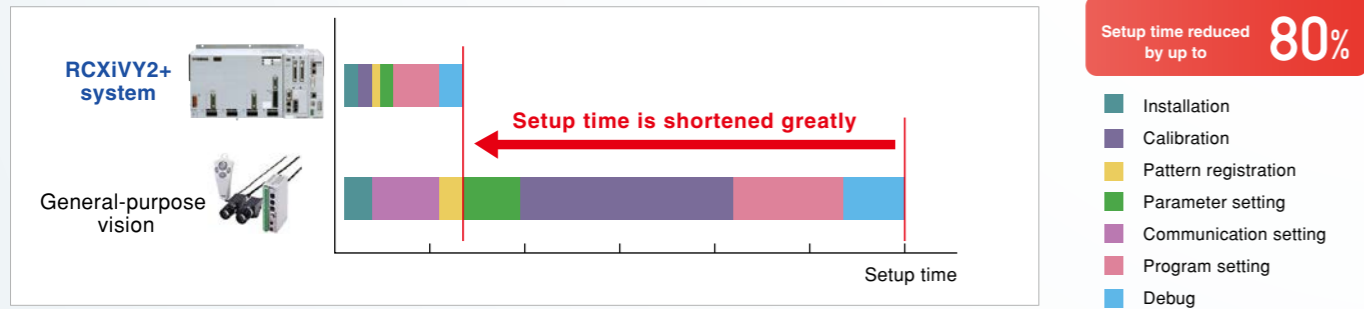

[Easy link with peripheral equipment]

One controller provides unified control of robot, gripper, and lighting.

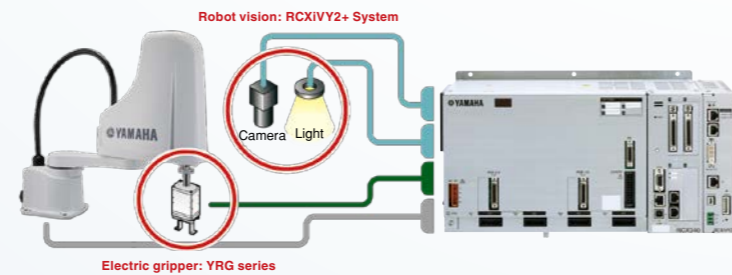

[System configuration illustration]

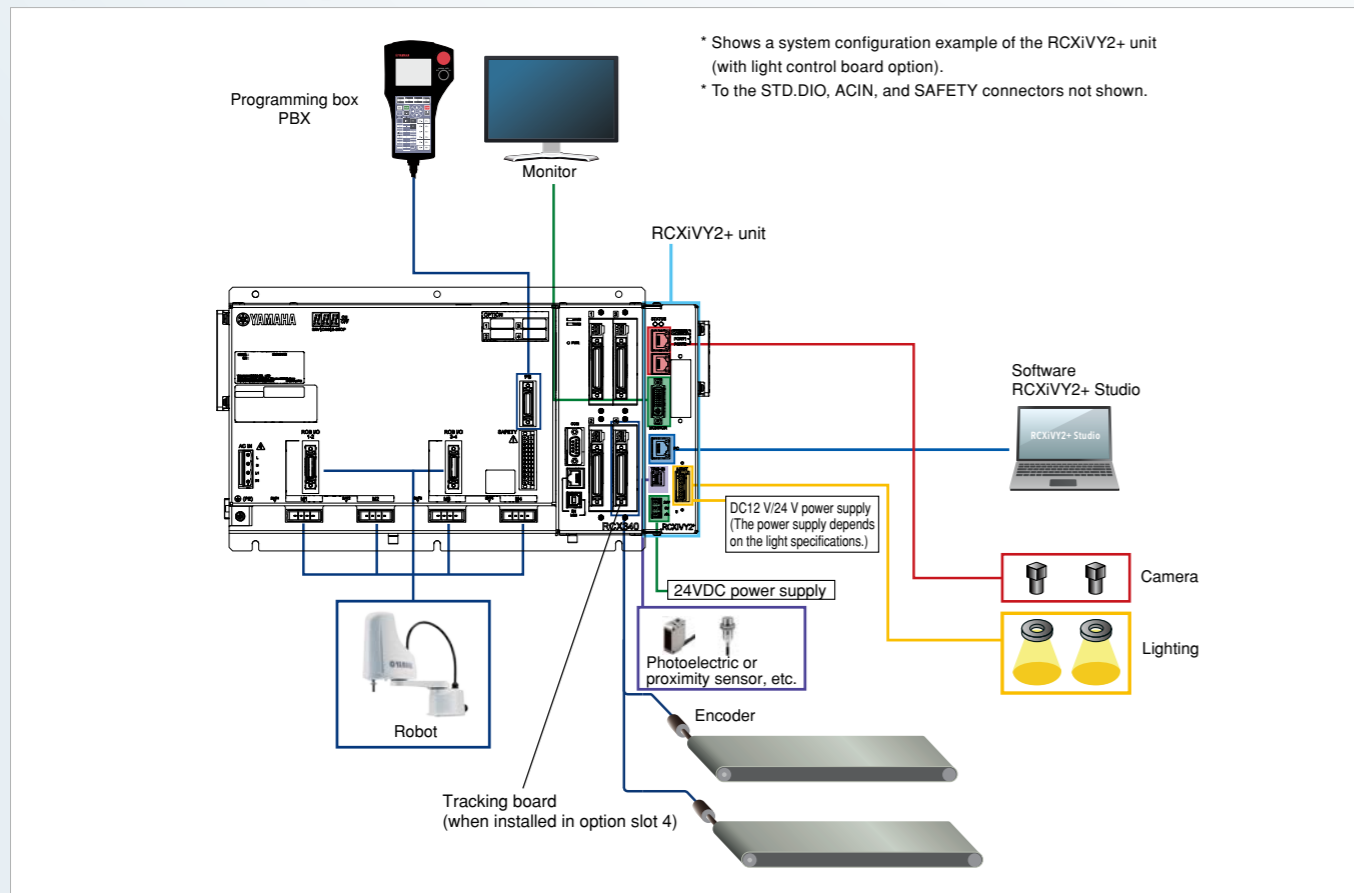

[Conveyor tracking]

Ideal for high-speed packaging arrangement high-speed transport of multiple types of items such as pharmaceuticals, cosmetics, and food products.

The vision camera detects the position and orientation of parts moving on the conveyor, and the robot picks them up.

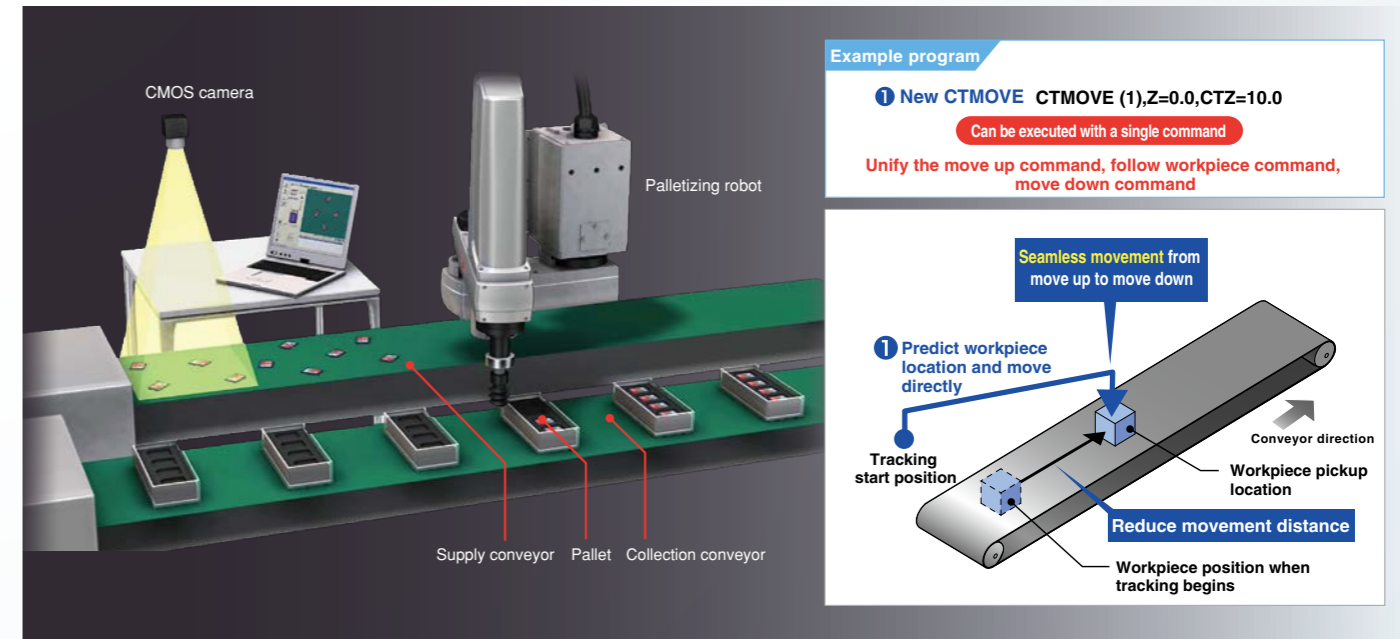

Operating conditions: YK500XG / payload 1 kg (total of workpiece and tool) / horizontal movement 250 mm / vertical movement 1 mm / conveyor speed 100 mm/sec

[Improving productivity by controlling multiple robot systems]

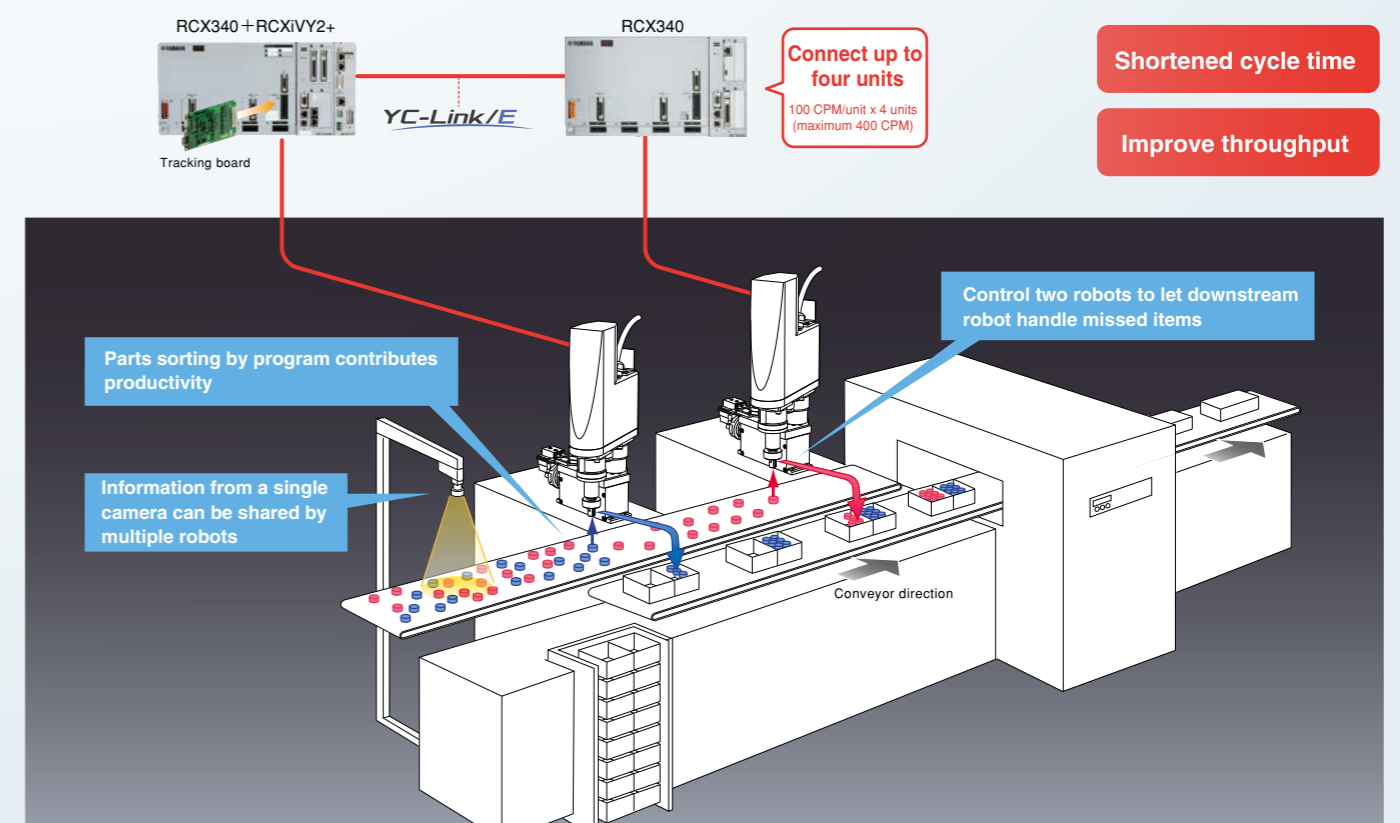

[Up to 254 types of parts registration]

Setup changes require only that part numbers be changed. Setup changes are easy.

254 types (0-253) can be registered



[High-precision search even under low light]

Edge search engine is built-in

Supports a variety of applications while being minimally affected by the external environment.

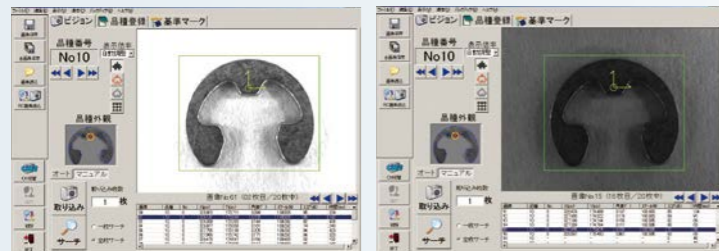

When lighting is sufficient

Accurate search even if lighting is insufficient

[Monitor output]

Monitor the operating status

Monitor the search status while making calibration settings or during automatic operation.

Contents of output

- Selected type / Captured image
- Search result (position, score, scale)
- Executed command
- Time required by command

Output method

- DVI-I (supports digital monitor or analog monitor)

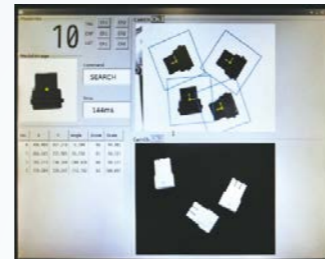

[Lens distortion and camera inclination correction function]

Mounting accuracy is improved. Camera is installed in the inclined status. *

* Up to approx. 15 degrees

The lens distortion and camera inclination when the angle of visibility is wide or when the camera is installed in the inclined status can be corrected.

When the distortion and inclination correction function is enabled during calibration, the calibration data for the distortion and inclination correction is created. When images are captured using this calibration data, captured images are corrected and output.

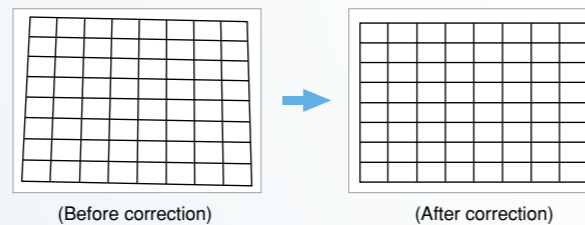

(Before correction)

(After correction)

Camera position can be selected in accordance with the application.

Fixed camera Fixed downward.

Fixed upward.

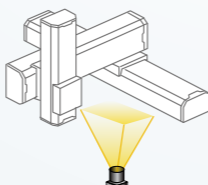
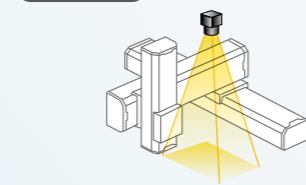

Movable camera SCARA robots

Cartesian robots

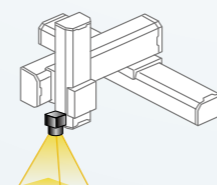
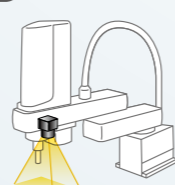

Even when the camera is moved, the coordinates are corrected automatically.

[Also supports moving camera]

Even if the camera is mounted on the robot, coordinates are automatically converted according to the robot's movement.

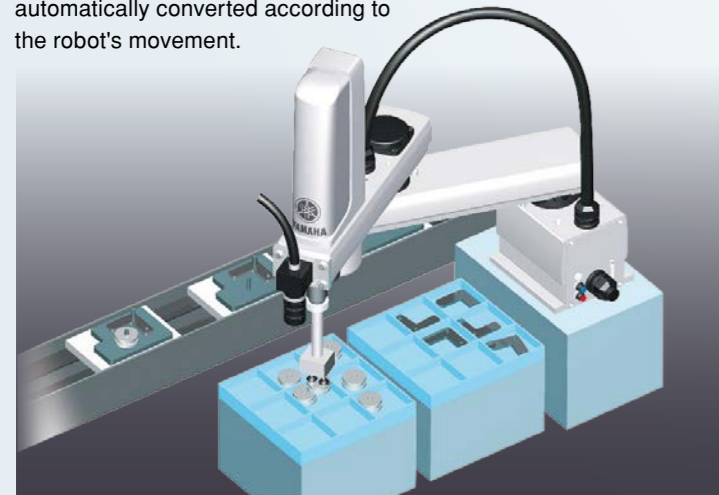

[Easy-to-use programming software RCXiVY2+ Studio]

With programming software "RCXiVY2+ Studio", all vision related operations such as registration of fiducial marks and workpieces used for calibration (contour settings, various parameter settings, and read range settings), backup, restore operation, and operation monitor can be performed.

- Search trial-run, part type registration
- Reference mark registration (for calibration)
- Up to 254 workpiece types can be registered.
- Workpiece can also be added easily.
- Up to 100 workpieces can be detected at once.
- Data backup
- This software functions as a monitor during program operation.



Download from website (member site)

[Easy programming]

Constructing the most suitable robot vision system for an application.

RCX-Studio 2020 program template function

- ◆ Program is created automatically simply following step-by-step operating process

RCX3 series programming software RCX-Studio 2020 also has following five templates for vision system:

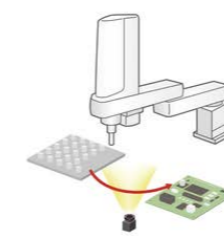

- Pallet picking using the vision
- Dispensing work using the vision
- Gripping deviation correction using the vision
- Gripping deviation and mounting position correction using the vision
- Gripping deviation and mounting position correction using the vision (without using any master)

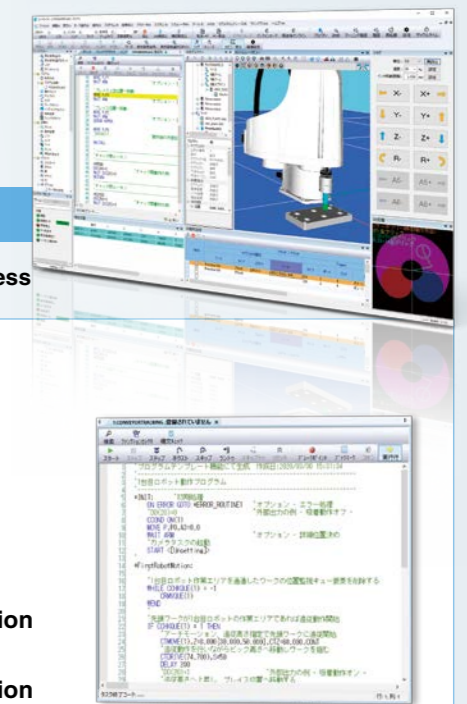

Wide variety of robot system to choose from most suitable and economical solution for robot vision system



XY-X Cartesian robots

YK-XG/XE SCARA robots

YK-TW orbit type robots

FLIP-X single-axis robots

* The YA series is not supported.

[Verifying application prior to purchase]

User's application is verified using actual sample parts before making a purchase decision.
Based on the evaluation result, recommendation will be made for most suitable and economical solution.

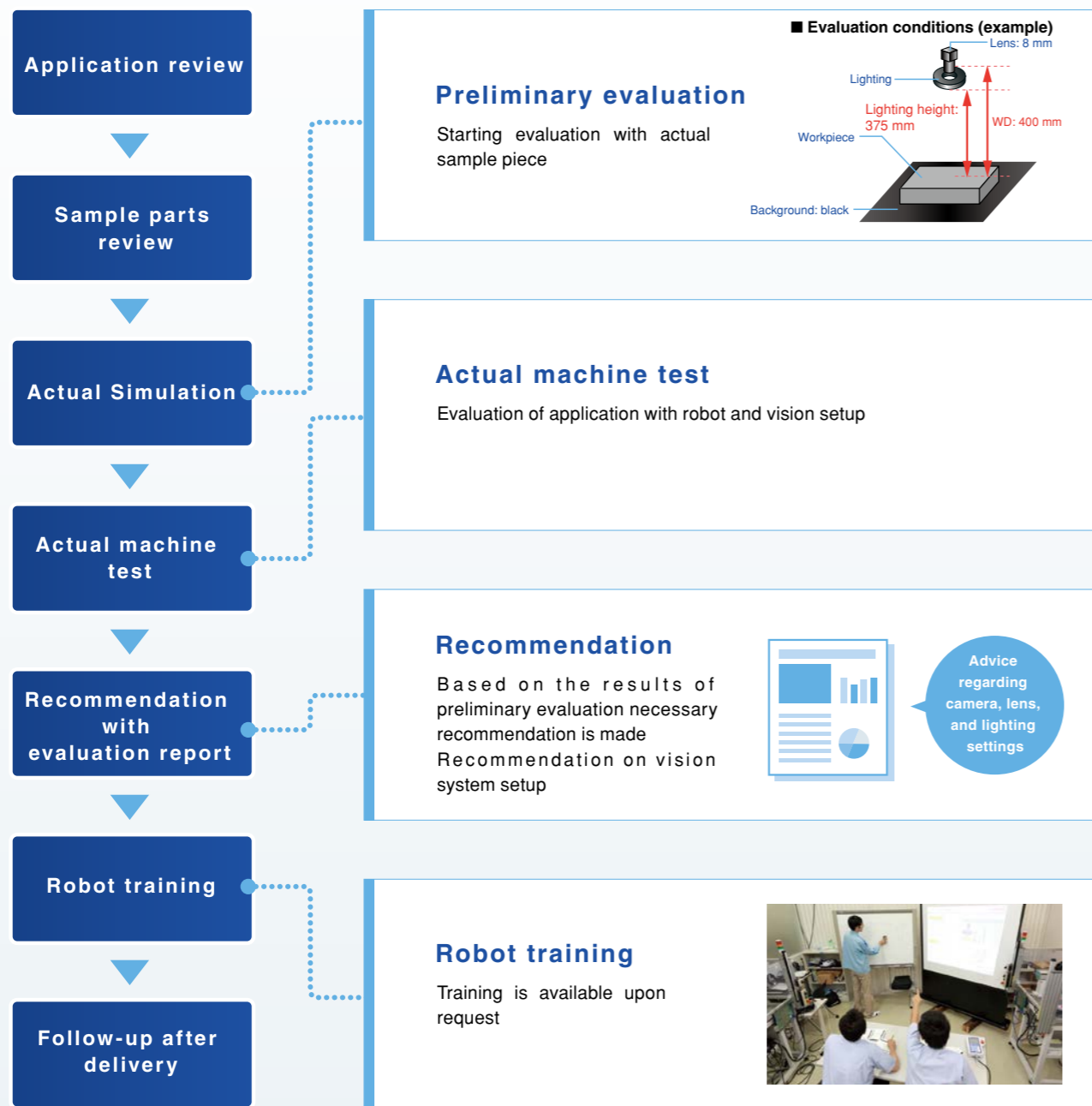

▶ For customers who consider to replace “iVY2” with “RCXiVY2+”

Workpieces that have been able to be recognized by the iVY2 system can also be detected by the RCXiVY2+ system under the same conditions without changing the installation position. Therefore, it is not necessary to evaluate the workpieces again. However, the exposure time and aperture may need to be adjusted. In addition, since the installation hole positions of the camera are changed, the plate of the installation section needs to be changed.

[Lot application examples]

Application 1: Random flow of parts on conveyor
The workpiece positions are recognized by the camera and the labels are adhered to the determined positions on workpieces. The adhesion position can also be specified for each part type.

- The camera recognizes the position. **POINT**
- The positions, orientations, and clearances are not aligned. Even when the positions or orientations of workpieces that are flown are not aligned, the labels are adhered to the same positions.
- The label is adhered to the determined position.
- Workpieces are flown.

Application 2: Automatically adjusting sealing points
Position of workpiece is correctly recognized by its shape. Changing setup or jig between production lot can be eliminated.

- The workpiece shape is recognized by the camera and the sealing is applied to the correct position. **POINT**
- The camera recognizes the workpiece position.
- The workpiece is placed within the specified area.
- The sealing is applied correctly.

Application 3: Adjusting screw fastening position
Vision camera recognizes actual hole position with wide tolerance and adjust fastening position.

- Wide tolerance of hole position even after parts are positioned. **POINT**
- Camera recognizes tolerance. Even when there are variations in product accuracy such as resin mold product, the products can be assembled correctly.
- The screw is tightened correctly.

Application 4: “Pick-and-Assemble” in one motion
Pick up parts from a tray, adjust position on the fly and install directly.

- Workpiece is assembled at the correct position. **POINT**
- Use of the upward camera makes it possible to correct the position during transfer.
- Workpieces are positioned roughly in the tray.
- Camera corrects the workpiece position during transfer.

Application 5: Conveyor tracking
Pick-and-place operation of randomly positioned parts on conveyor by SCARA robot. Position and orientation of parts are recognized by vision camera.

- Handling process is reduced without teaching. **POINT**

Application 6: Irregular shape workpieces such as foods and clothes
Pick-and-place with conveyor tracking for parts with wide tolerance like foods and clothes.

- Increasing productivity with two robots. **POINT**

Ordering method

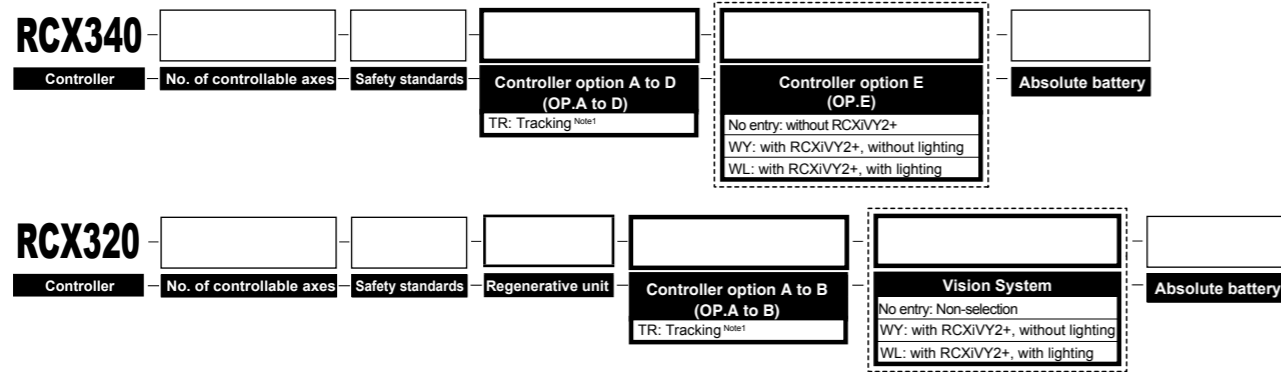

Note1. Only one tracking board can be selected.
 Refer to the comprehensive catalog for details on the order format.

Robot vision basic specifications

Item	RCXiVY2+ unit	
Basic specifications	Applicable controllers	RCX340/RCX320
	Number of screen pixels	720(H) × 540(V) (400,000 pixels) 1440(H) × 1080(V) (1,600,000 pixels) 2048(H) × 1536(V) (3,200,000 pixels) 2592(H) × 1944(V) (5,000,000 pixels) ^{Note1}
	Model setting capacity	254 models
	Number of connectable cameras	2 cameras
	Connectable camera	GigE camera PoE: IEEE802.3af 1 ch up to 7W
	External interface	Ethernet (1000BASE-T) ^{Note2} USB 2.0 2Ch (Up to 5V 2.5W / ch) ^{Note3}
	External monitor output	DVI-I ^{Note4} Monitor resolution: 1024 × 768 Vertical periodic frequency: 60 Hz Horizontal periodic frequency: 48.4 kHz
	Power supply	24 VDC +/-10%, Maximum 1.5 A
	Dimensions	W45 × H195 × D130 (RCXiVY2+ unit only)
	Weight	0.8kg (RCXiVY2+ unit only, when the lighting control board option is selected)
Operating environment	Compliant with the RCX340/RCX320 controller.	
Storage environment	Compliant with the RCX340/RCX320 controller.	
Search method	Edge search (correlated edge filter, sobel filter), Measurement function, Blob search	
Image capturing	Trigger mode	S/W trigger, H/W trigger
	External trigger input	2 points
Function	Position detection, coordinate conversion, automatic point data generation, distortion and inclination correction	
Camera installation position	Fixed to the fixed camera (up, down) or robot (Y-axis, Z-axis). Perpendicular to the workpiece to be captured.	
Setting support function	Calibration, image save function, model registration ^{Note5} , fiducial mark registration ^{Note5} , measurement function registration ^{Note5} , blob registration ^{Note5} , monitor function ^{Note5}	
Lighting control options	Number of connectable lighting units	Maximum 2
	Modulated light format	PWM modulated light control (0 to 100%), PWM frequency switchable 62.5 kHz/ 125 kHz Continuous light, strobe light (follows camera exposure)
	Lighting power input	12VDC or 24VDC (external supply shared by both channels)
	Lighting output	For 12VDC supply: Total of less than 40W for both channels. For 24VDC supply: Total of less than 80W for both channels.

Note1. Since the rolling shutter is used, the tracking is not supported.
 Note2. For setting and monitor operations
 Note3. It is planned to support this USB later.
 Note4. Also usable with an analog monitor by using a conversion adaptor.
 Note5. RCXiVY2+ Studio function (requires a Windows PC)

Tracking board basic Specifications

Item	Tracking board	
Basic specifications	Applicable controllers	RCX340/RCX320
	Number of connected encoders	Up to 2 units.
	Encoder power supply	5VDC (2 counters total 500 mA or less) (Supplied from controller)
	Applicable encoder	26LS31/26C31 or equivalent line driver (RS-422 compliance).
	Input phase	A, \bar{A} , B, \bar{B} , Z, \bar{Z}
	Max. response frequency	2MHz or less
	Counter	0 to 65535
	Multiplier	4x
	Other	With disconnection detection function

Standard accessories

RCXiVY2+ unit

The RCXiVY2+ unit adds robot vision to the RCX340/RCX320 robot controller.

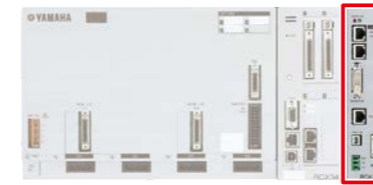

Model	No lighting	KFR-M4400-V0
	With lighting	KFR-M4400-L0

RCXiVY2+ unit accessories

Camera trigger input cable connector

Model	KX0-M657K-00
-------	--------------

24V power supply connector

Model	KCF-M5382-00
-------	--------------

Support software for PC RCXiVY2+ Studio

RCXiVY2+ Studio is programming software for the RCXiVY2+ system that allows registering part types and reference marks as well as monitoring the work search status during automatic robot operation by connecting to the robot controller.



[Download from website \(member site\)](#)

Environment

OS	Microsoft Windows XP / Vista (32 bit / 64 bit) / 7 (32 bit / 64 bit) / 8, 8.1 (32 bit / 64 bit) / 10 (32 bit / 64 bit)
CPU	Processor that meets or exceeds the suggested requirements for the OS being used.
Memory	Suggested amount of memory or more for the OS being used.
Hard disk capacity	30MB of available space required on installation drive. * Additional vacant space is required for saving images and data.
Display	800 × 600 dot, or higher, 32768 colors (16bit High Color) or higher (recommended)
Communication Port	Ethernet Port of TCP/IP

* Microsoft, Windows XP, Windows Vista, Windows 7, Windows 8, 8.1, and Windows 10 are registered trademarks of the Microsoft Corporation, USA.
 * Ethernet is a registered trademark of the XEROX Corporation, USA.

Options

CMOS camera



Model	400,000 pixel	720(H) × 540(V)	KFR-M6541-00
	1,600,000 pixel	1440(H) × 1080(V)	KFR-M6541-10
	3,200,000 pixel	2048(H) × 1536(V)	KFR-M6541-20
	5,000,000 pixel	2592(H) × 1944(V)	KFR-M6541-30

Lens



Model	8mm	KCX-M7214-00
	12mm	KCX-M7214-10
	16mm	KCX-M7214-20
	25mm	KCX-M7214-30
	8mm (megapixel support)	KCX-M7214-40
	12mm (megapixel support)	KCX-M7214-50
	16mm (megapixel support)	KCX-M7214-60
	25mm (megapixel support)	KCX-M7214-70

* Common to iVY2.

Close-up ring



Model	0.5mm	KX0-M7215-00
	1.0mm	KX0-M7215-10
	2.0mm	KX0-M7215-20
	5.0mm	KX0-M7215-40

Camera cable

Cable for connecting the camera to the RCXiVY2+ board.

Model	5m	KCX-M66F0-00
	10m	KCX-M66F0-10
	15m	KCX-M66F0-20

External diagram of camera cable

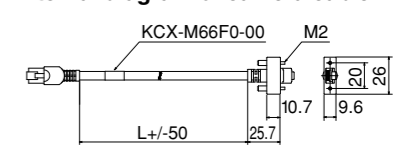

* Common to iVY2.

Lighting control board

This board adds lighting control functionality to the RCXiVY2+ system. (Installed in the RCXiVY2+ unit when shipped)

Model	KCX-M4403-L0
-------	--------------

Lighting control board accessories

Lighting power cable connector

Model	KX0-M657K-10
-------	--------------

Tracking board

This board adds conveyor tracking functionality to the RCX340/RCX320 controller.

Model	KCX-M4400-T0
-------	--------------

Tracking board accessories

Tracking encoder connector

Model	KX0-M657K-20
-------	--------------

Calibration jig

(Large and small attachments are provided.)

Model	KCX-M7200-00
-------	--------------

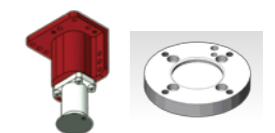

LAN cable with shield cloth (5 m)

Model	KX0-M55G0-00
-------	--------------



Tracking encoder cable (10 m)

Model	KX0-M66AF-00
-------	--------------



Dimensional outlines

RCX340+RCXiVY2+

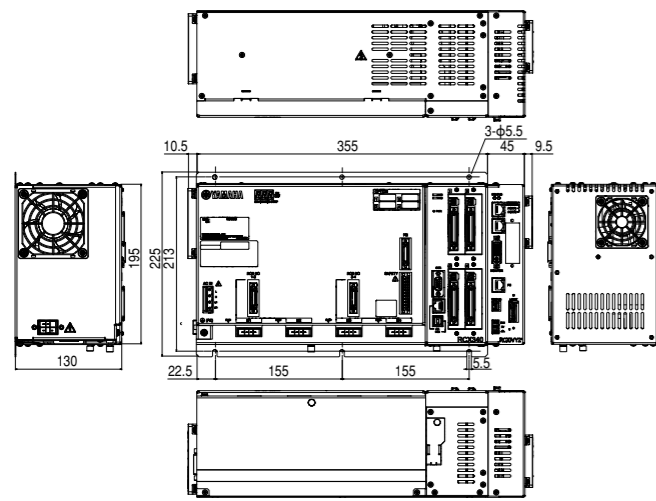

RCX320+RCXiVY2+

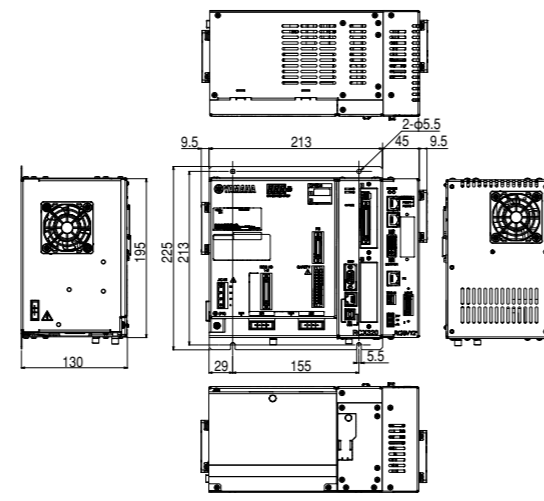

Dimensional outlines

Camera

● CMOS camera (400,000 pixel • 1,600,000 pixel • 3,200,000 pixel)

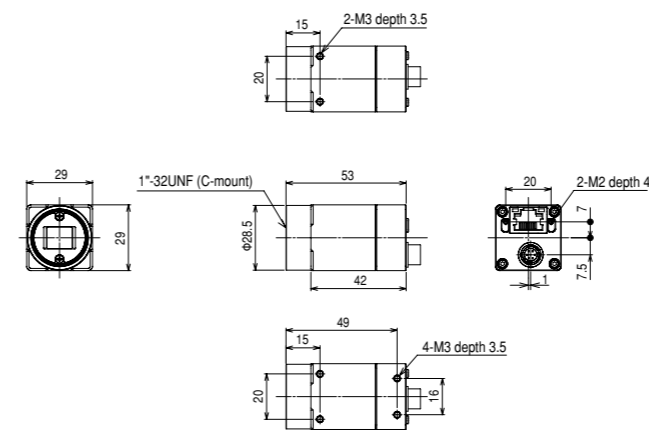

● CMOS camera (5,000,000 pixel)

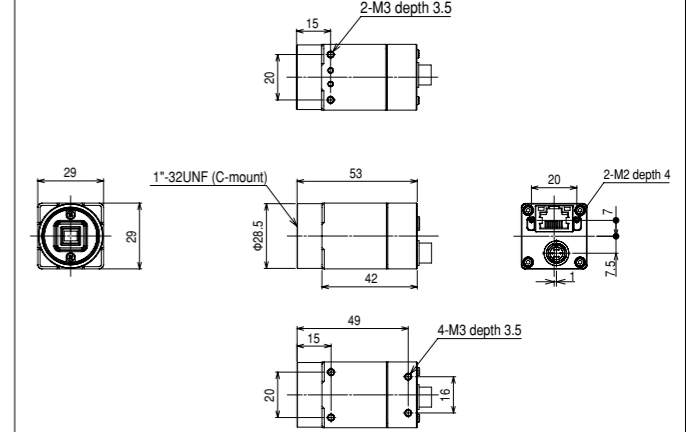

Calibration jig

Calibration jig

Model: KCX-M7200-00

Mark gripper dimension

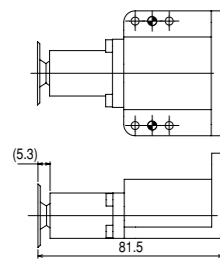

Mark dimension

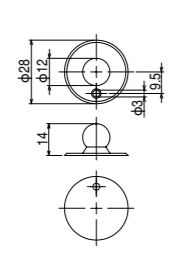

Body dimension

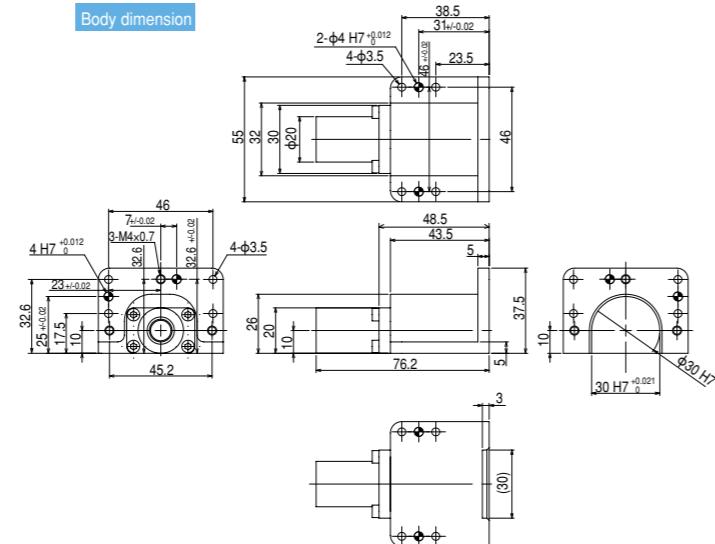

When using attachment (large)

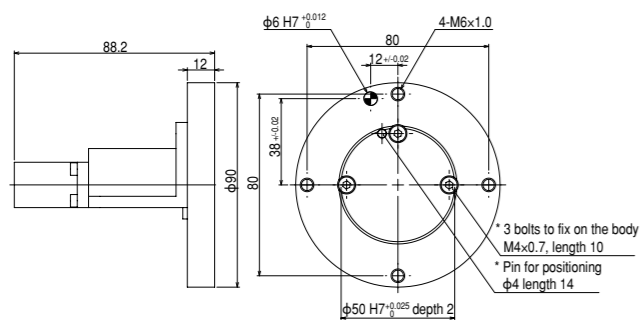

When using attachment (small)

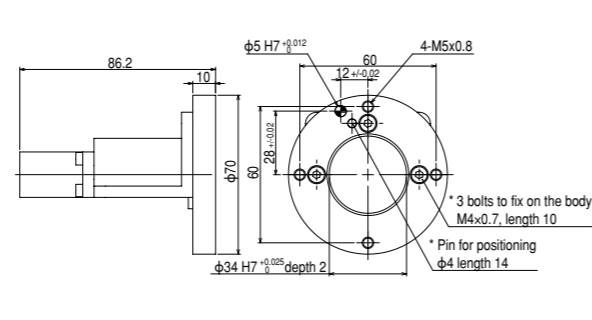

Lenses

8 mm lens

Model: KCX-M7214-00

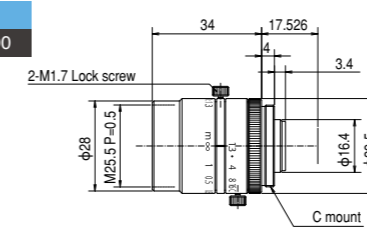

8 mm lens (megapixel support)

Model: KCX-M7214-40

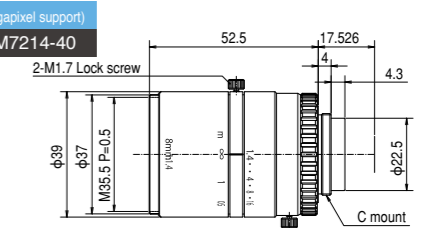

12 mm lens

Model: KCX-M7214-10

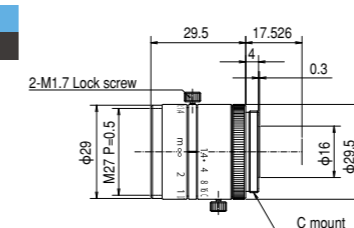

12 mm lens (megapixel support)

Model: KCX-M7214-50

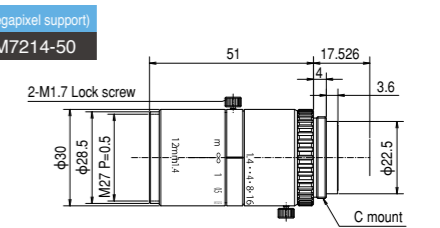

16 mm lens

Model: KCX-M7214-20

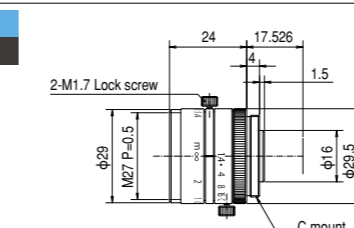

16 mm lens (megapixel support)

Model: KCX-M7214-60

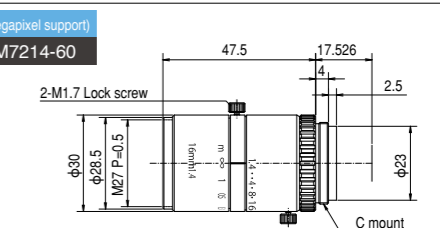

25 mm lens

Model: KCX-M7214-30

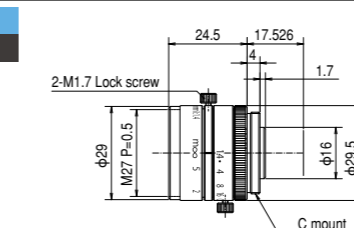

25 mm lens (megapixel support)

Model: KCX-M7214-70

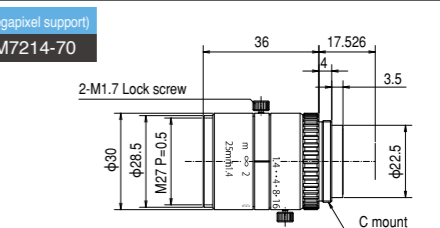

● Lens characteristics

Lens	Model	Focal length [mm]	Aperture value [F No.]	Angle-of-view (degrees)								Closest approach distance [m]
				KFR-M6541-00 (400,000 pixel camera)		KFR-M6541-10 (1,600,000 pixel camera)		KFR-M6541-20 (3,200,000 pixel camera)		KFR-M6541-30 (5,000,000 pixel camera)		
				Vertical	Horizontal	Vertical	Horizontal	Vertical	Horizontal	Vertical	Horizontal	
8mm	KCX-M7214-00	8	F1.3-CLOSE	27.13	36.09	26.85	35.69	37.57	49.23	30.72	40.60	0.2
12mm	KCX-M7214-10	12	F1.4-CLOSE	17.23	23.01	17.05	22.74	24.11	31.95	19.57	26.03	0.3
16mm	KCX-M7214-20	16	F1.4-CLOSE	13.17	17.50	13.03	17.30	18.48	24.44	14.97	19.83	0.4
25mm	KCX-M7214-30	25	F1.4-CLOSE	8.57	11.42	8.47	11.29	12.05	16.01	9.74	12.95	0.5
8mm (megapixel support)	KCX-M7214-40	8	F1.4-F16	26.47	34.83	26.20	34.44	36.68	47.61	29.97	39.21	0.1
12mm (megapixel support)	KCX-M7214-50	12	F1.4-F16	17.49	23.19	17.31	22.92	24.47	32.19	19.86	26.23	0.1
16mm (megapixel support)	KCX-M7214-60	16	F1.4-F16	13.28	17.69	13.14	17.48	18.64	24.69	15.09	20.04	0.1
25mm (megapixel support)	KCX-M7214-70	25	F1.4-F16	8.62	11.48	8.52	11.34	12.12	16.09	9.80	13.02	0.15

Note. This table shows the angle-of-view for Yamaha's standard lenses. If the angle-of-view is greater, there might be more distortion at the edge of the image.

● Angle-of-view size, WD, and magnification when close-up ring is used

Close-up ring [mm]			Lens			
			8 mm KCX-M7214-00	12mm KCX-M7214-10	16mm KCX-M7214-20	25mm KCX-M7214-30
None	Angle-of-view size X × Y [mm]	WD[mm]	200	300	400	500
		KFR-M6541-00 (400,000 pixels)	97.8 × 130.5	93 × 124	93 × 124	72.9 × 97.2
		KFR-M6541-10 (1,600,000 pixels)	98.6 × 130.5	93.7 × 124	93.7 × 124	73.5 × 97.2
		KFR-M6541-20 (3,200,000 pixels)	139.2 × 185.7	132.2 × 176.5	132.2 × 176.5	103.7 × 138.4
		KFR-M6541-30 (5,000,000 pixels)	112.3 × 150	106.7 × 142.5	106.7 × 142.5	83.7 × 111.7
	Optical magnification	0.038	0.040	0.040	0.051	
0.5	Angle-of-view size X × Y [mm]	WD[mm]	69.5	118.6	143	296.8
		KFR-M6541-00 (400,000 pixels)	37.2 × 49.6	60 × 80	46.5 × 62	93 × 124
		KFR-M6541-10 (1,600,000 pixels)	37.5 × 49.6	60.4 × 80	46.8 × 62	93.7 × 124
		KFR-M6541-20 (3,200,000 pixels)	52.9 × 70.6	85.3 × 113.8	66.1 × 88.2	132.2 × 176.5
		KFR-M6541-30 (5,000,000 pixels)	42.7 × 57	68.8 × 91.9	53.3 × 71.2	106.7 × 142.5
	Optical magnification	0.100	0.062	0.080	0.040	
1.0	Angle-of-view size X × Y [mm]	WD[mm]	38.7	53.8	91.3	142.3
		KFR-M6541-00 (400,000 pixels)	22.9 × 30.6	30 × 40	31 × 41.3	46.5 × 62
		KFR-M6541-10 (1,600,000 pixels)	23.1 × 30.6	30.2 × 40	31.2 × 41.3	46.8 × 62
		KFR-M6541-20 (3,200,000 pixels)	32.6 × 43.5	42.6 × 56.9	44 × 58.8	66.1 × 88.2
		KFR-M6541-30 (5,000,000 pixels)	26.3 × 35.1	34.4 × 45.9	35.5 × 47.5	53.3 × 71.2
	Optical magnification	0.162	0.124	0.120	0.080	
1.5	Angle-of-view size X × Y [mm]	WD[mm]			65.4	90.8
		KFR-M6541-00 (400,000 pixels)			23.1 × 30.8	30.7 × 40.9
		KFR-M6541-10 (1,600,000 pixels)			23.2 × 30.8	30.9 × 40.9
		KFR-M6541-20 (3,200,000 pixels)			32.8 × 43.8	43.7 × 58.3
		KFR-M6541-30 (5,000,000 pixels)			26.5 × 35.4	35.2 × 47.1
	Optical magnification			0.161	0.121	
2.0	Angle-of-view size X × Y [mm]	WD[mm]			50	65.1
		KFR-M6541-00 (400,000 pixels)			18.5 × 24.6	23.1 × 30.8
		KFR-M6541-10 (1,600,000 pixels)			18.6 × 24.6	23.2 × 30.8
		KFR-M6541-20 (3,200,000 pixels)			26.3 × 35.1	32.8 × 43.8
		KFR-M6541-30 (5,000,000 pixels)			21.2 × 28.3	26.5 × 35.4
	Optical magnification			0.201	0.161	
5.0	Angle-of-view size X × Y [mm]	WD[mm]				104.2
		KFR-M6541-00 (400,000 pixels)				14.8 × 19.8
		KFR-M6541-10 (1,600,000 pixels)				15 × 19.8
		KFR-M6541-20 (3,200,000 pixels)				21.1 × 28.2
		KFR-M6541-30 (5,000,000 pixels)				17 × 22.8
	Optical magnification				0.250	

* WD is the lens tip reference.

Close-up ring [mm]			Lens			
			8 mm lens for megapixel KCX-M7214-40	12 mm lens for megapixel KCX-M7214-50	16 mm lens for megapixel KCX-M7214-60	25 mm lens for megapixel KCX-M7214-70
None	Angle-of-view size X × Y [mm]	WD[mm]	100	100	100	150
		KFR-M6541-00 (400,000 pixels)	53.1 × 70.8	37.2 × 49.6	27.3 × 36.4	24.9 × 33.2
		KFR-M6541-10 (1,600,000 pixels)	53.5 × 70.8	37.5 × 49.6	27.5 × 36.4	25.1 × 33.2
		KFR-M6541-20 (3,200,000 pixels)	75.5 × 100.8	52.9 × 70.6	38.8 × 51.9	35.5 × 47.3
		KFR-M6541-30 (5,000,000 pixels)	61 × 81.4	42.7 × 57	31.3 × 41.9	28.6 × 38.2
	Optical magnification	0.070	0.100	0.136	0.149	
0.5	Angle-of-view size X × Y [mm]	WD[mm]	46	113.6	66.1	283.2
		KFR-M6541-00 (400,000 pixels)	28.1 × 37.5	59 × 78.7	25.8 × 34.4	90.7 × 120.9
		KFR-M6541-10 (1,600,000 pixels)	28.4 × 37.5	59.5 × 78.7	26 × 34.4	91.4 × 120.9
		KFR-M6541-20 (3,200,000 pixels)	40 × 53.4	83.9 × 112	36.7 × 49	129 × 172.1
		KFR-M6541-30 (5,000,000 pixels)	32.3 × 43.1	67.7 × 90.4	29.6 × 39.5	104.1 × 139
	Optical magnification	0.132	0.063	0.144	0.041	
1.0	Angle-of-view size X × Y [mm]	WD[mm]	47.2	131.9	62.6	243
		KFR-M6541-00 (400,000 pixels)	20.1 × 26.8	45.9 × 61.2	18.8 × 25.1	60 × 80
		KFR-M6541-10 (1,600,000 pixels)	20.2 × 26.8	46.2 × 61.2	19 × 25.1	60.4 × 80
		KFR-M6541-20 (3,200,000 pixels)	28.5 × 38.1	65.3 × 87.1	26.8 × 35.8	85.3 × 113.8
		KFR-M6541-30 (5,000,000 pixels)	23 × 30.8	52.7 × 70.3	21.6 × 28.9	68.8 × 91.9
	Optical magnification	0.185	0.081	0.197	0.062	
1.5	Angle-of-view size X × Y [mm]	WD[mm]	35.2	81.4	51.5	155.5
		KFR-M6541-00 (400,000 pixels)	16.5 × 22	33.2 × 44.2	16.3 × 21.7	40 × 53.3
		KFR-M6541-10 (1,600,000 pixels)	16.6 × 22	33.4 × 44.2	16.4 × 21.7	40.3 × 53.3
		KFR-M6541-20 (3,200,000 pixels)	23.5 × 31.3	47.2 × 63	23.2 × 30.9	56.8 × 75.9
		KFR-M6541-30 (5,000,000 pixels)	18.9 × 25.3	38.1 × 50.8	18.7 × 25	45.9 × 61.2
	Optical magnification	0.225	0.112	0.228	0.093	
2.0	Angle-of-view size X × Y [mm]	WD[mm]			43	111.7
		KFR-M6541-00 (400,000 pixels)			14.3 × 19.1	30.2 × 40.3
		KFR-M6541-10 (1,600,000 pixels)			14.4 × 19.1	30.4 × 40.3
		KFR-M6541-20 (3,200,000 pixels)			20.4 × 27.2	43 × 57.3
		KFR-M6541-30 (5,000,000 pixels)			16.4 × 22	34.7 × 46.3
	Optical magnification			0.259	0.123	
5.0	Angle-of-view size X × Y [mm]	WD[mm]				53.9
		KFR-M6541-00 (400,000 pixels)				10.6 × 14.2
		KFR-M6541-10 (1,600,000 pixels)				10.7 × 14.2
		KFR-M6541-20 (3,200,000 pixels)				15.1 × 20.2
		KFR-M6541-30 (5,000,000 pixels)				12.2 × 16.3
	Optical magnification				0.349	

* The above table shows the field of view when the standard lens and close-up ring are used. (Closest distance value is shown in No Close-up Ring column).

* If a close-up ring is not used, a WD less than the value shown in this table cannot be used.

* If a close-up ring is used, only WD in the region of this value can be used.

* Values in this table are for reference only; Actual values may vary

YAMAHA MOTOR CO., LTD.

Robotics Operations FA Section

127 Toyooka, Kita-ku, Hamamatsu, Shizuoka 433-8103, Japan
Tel. +81-53-525-8350 Fax. +81-53-525-8378

URL <https://global.yamaha-motor.com/business/robot/>
E-mail robotn@yamaha-motor.co.jp

● Specifications and appearance are subject to change without prior notice.